

User Guide

Wide Format Scanner



Models: IQ Quattro X Series

UG14405-1D EN IQQ X AUG 2020

Contents	2
About this Guide	2
Overview	3
Specification	4
Overview	5
Front view	5
Rear view	6
Installation	7
System requirements	7
Installation step by step	7
Software installation	8
Clean the scanner	9
Connecting the power cable	11
Turn on the scanner	12
Connecting the USB 3.0 cable	12
Setting the Energy Star sleep timer	14
Online scanner activation	16
Manual scanner activation	17
Scanner calibration	18
Using the scanner on a network (Ethernet)	20
Removing a networked scanner)	23
Changing scanner network settings	24
Turning the Scanner ON and OFF	25
Sleep and wake modes	26
Automatic shut down after idle time	27
Loading Originals	28
Automatic loading	28
Manual loading	29
Unloading the original after the scan	29
Soft handling	30
Setting the input size	30
Scanning	31
Scanning software	31
Monitoring your scanner with WIDEsystem	32
Maintenance	33
About scanner maintenance	33
Cleaning the scan area	33
How to clean the parts inside the scanner	34
Calibration	41
Replacing the glass plate	45

How to replace the scanner glass plate	47
Downloading New Firmware	53
What is Firmware?	53
When do I need new firmware?	53
Identifying scanner firmware	53
Installing new firmware	53
Trouble-shooting	54
Scanner error reporting	54
Correcting scanner errors	54
Technical assistance	54
Scanner installation problems	55
Scanner operation problems	57
Scanner operation problems	58
Scanner maintenance problems	59
Scanner result problems	60
Important safety instructions	61
Appendix	61
Regulations	62
FCC Regulations	62
Scanner weights (unpacked) & dimensions	63
Low Adjustable Stand and High Adjustable Stand working heights	63

About this Guide

This guide explains how to operate and maintain your wide format scanner.

The guide assumes basic knowledge of your computer and operating system and does not repeat material from their documentation.

Please refer to:

- The [Installation section](#) for installation of your scanner drivers.
- The readme.htm file in the ws folder of the WIDEsystem Tools USB thumb drive. This contains the most current installation and OS compatibility issues.
- WIDEsystem TOOLS Help. After installing your drivers [open WIDEsystem](#) and press F1 to find more information about using the scanner maintenance software

This user guide covers the following models:

Scanner Name	Model Number	Description
IQ Quattro X 3600 Series	MV52D	36" color scanner
IQ Quattro X 4400 Series	MU52D	44" color scanner



All the above models are ENERGY STAR[®] compliant.

 **IMPORTANT:** Be sure to use the WIDEsystem USB thumb drive that came with your scanner or a newer version. Out-of-date versions of WIDEsystem software may not detect your scanner model correctly.

 **NOTE:** Different sizes of scanner use many standard parts and the number of catches and rollers varies according to model. Illustrations used in this guide are generic and may not always match the scanner you have purchased.



NOTE: Windows Compatibility - Your scanner and drivers are tested and developed to support the most current active Microsoft Windows operating systems. Drivers and interface support for specific Windows versions will follow the Microsoft Support Lifecycle Policy. The compatibility specifications can therefore change accordingly. The latest operating system drivers are available on the manufacturer's website.

IQ Quattro X Series large format CIS scanners have an improved Ethernet interface and enhanced USB 3.0. External touch tablet devices can also be used allowing wireless control of the scanner (operates in conjunction with the normal scanner pc running Nextimage). The 3600 and 4400 models have scan widths of 36” and 44” respectively. Both have 50 and 90 speed variants directly affecting the maximum color scan speeds achievable.

	IQ Quattro X 3600	IQ Quattro X 4400
Ethernet interface	Gigabit up to 100 MB/s xDTR2.5	
USB 3.0 interface	SuperSpeed up to 250 MB/s xDTR3.0	
Color / mono scan speed @ 200 dpi inches/sec (cm/sec)	17.8 / (45.2)	
Maximum imaging width mm (inches)	914 (36) / A0+ ANSI E	1118 44 / A0+ ANSI E+
Maximum document width mm (inches)	965 (38)	1194 (47)
Justification	Center	
Paper guidance system	Feed tray paper guides (magnetic) and removable paper return guides (rear mount)	
Optical resolution	1200x1200 dpi, interpolation to 9600 dpi	
Media thickness mm (inches)	2 (0.08) flexible documents only	
Accuracy	0.1% +/- 1 pixel	
Optical sensing with LED illumination	CIS dual illumination	
Paper size detection	Optimized automatic system	
Portable tablet remote system * (scanner mounted)	Scan and copy using portable device (connects to Nextimage)	
Power consumption: (Ready / Sleep Mode / Scanning)	Max 18W / <1W / 37W (built-in power supply)	
Scanning software	Contex Nextimage 5 for Windows, WIDEsystem and iOS / Android apps	
Unpacked weight kg (lbs) Dimensions W x D x H mm (inches)	21.9 (48.3) 1160 x 489 x 161 (45.7 x 19.3x 6.3)	24.5 (54) 1349 x 489 x 161 (53.1 x 19.3 x 6.3)
Packed weight kg (lbs) Dimensions W x D x H mm (inches)	28 (62) 1300 x 680 x 320 (51.2x 26.7x 12.6)	33 (73) 1490 x 680 x 320 (58.7 x 26.7x 12.6)
Packaging	Foam shock protection inside thick cardboard box	
Stand options	Low Adjustable (3 settings), High Adjustable (9 settings). See appendix	

* The tablet device referred to in this guide is not part of scanner supply. Free download of iOS or Android app. See datasheet for further details.

The parts, buttons and areas you need to recognize for using the scanner.

Front view

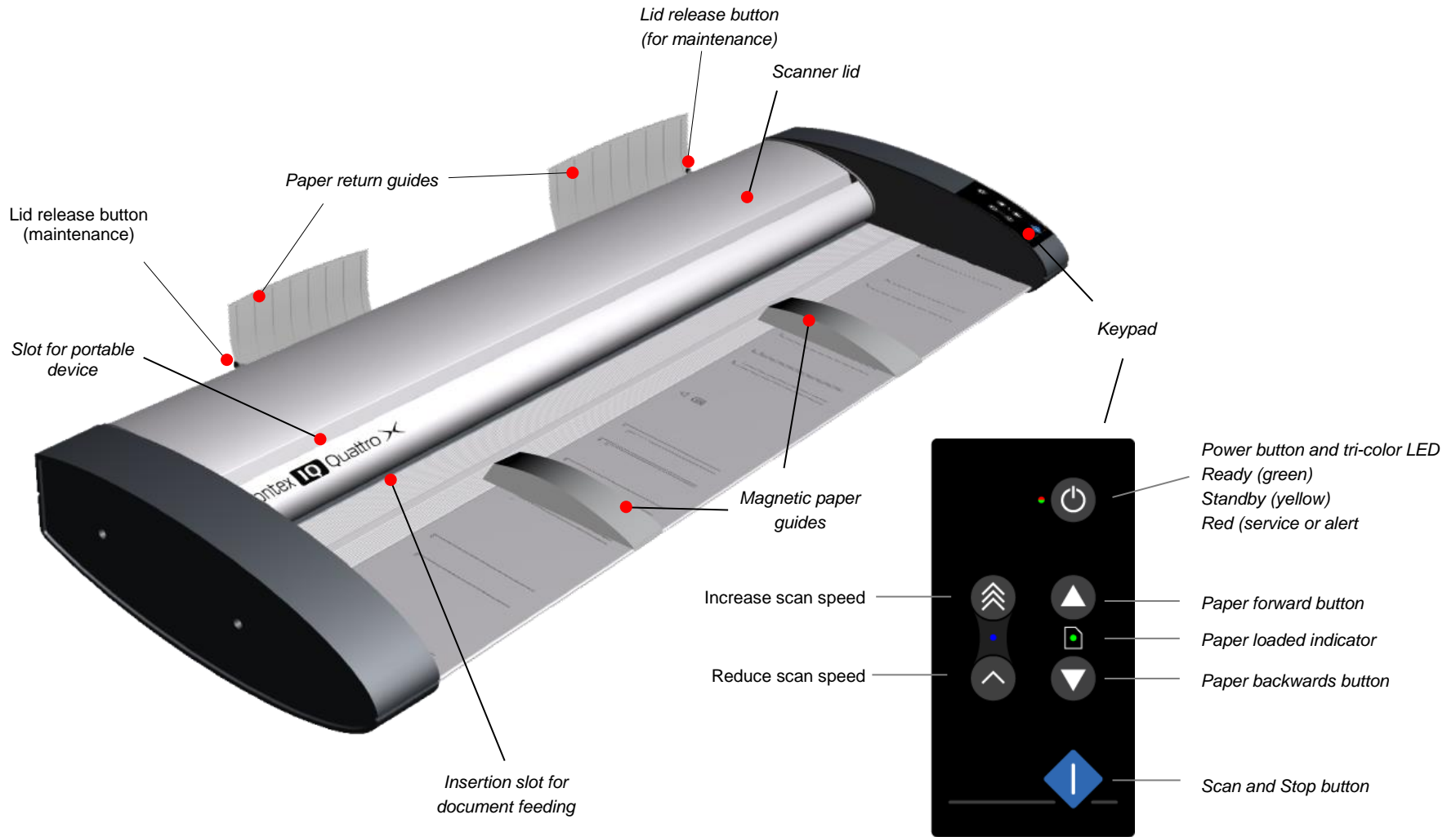

Rear view

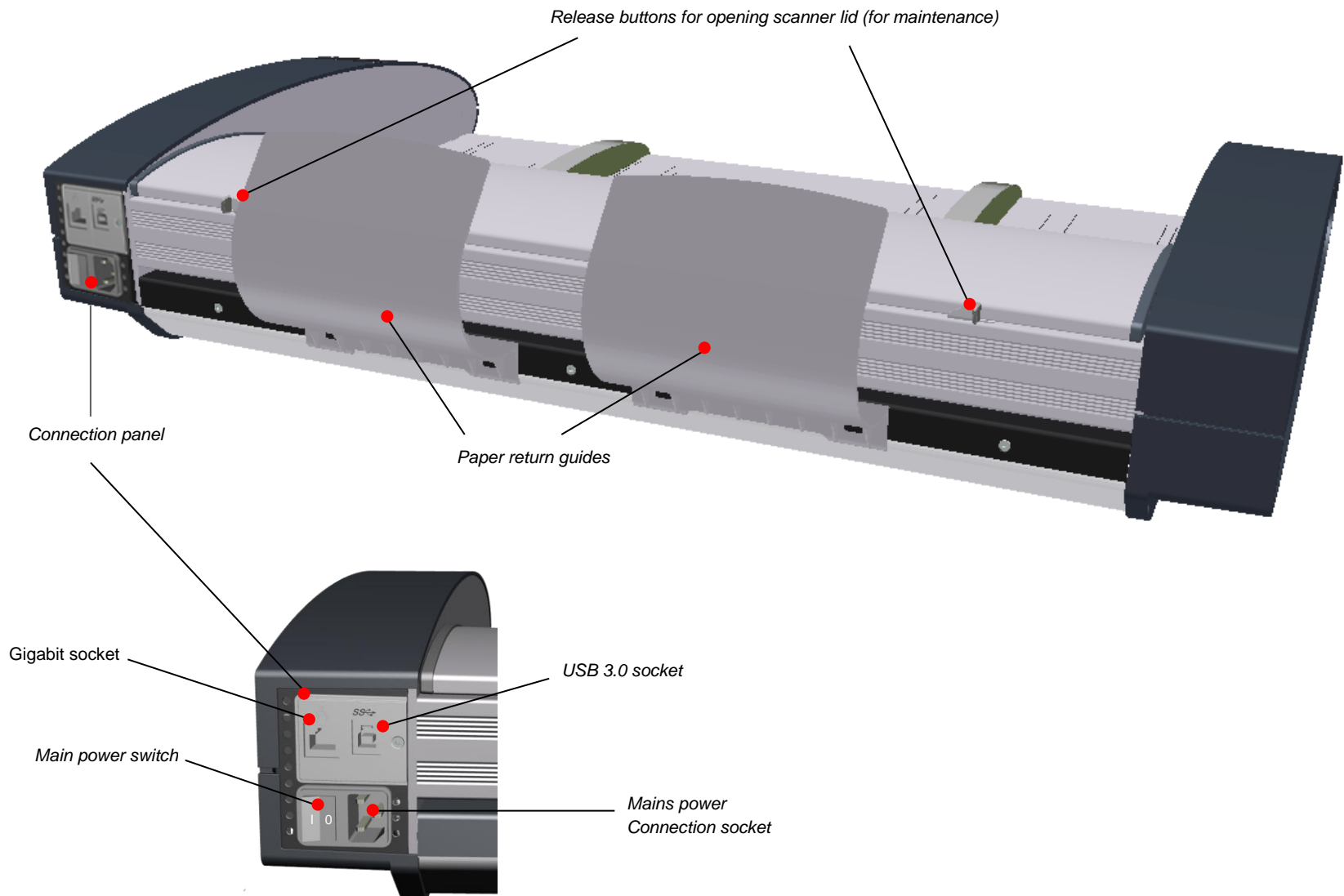

Follow the steps below for quick and easy installation of your scanner and scanner drivers.

System requirements

- Minimum recommended PC or workstation: Core 2 processor, 4 GB RAM, 5 GB of available hard drive space, USB 3.0 interface
- Compatible Windows operating system – View the readme.htm file on the WIDEsystem USB thumb drive
- Enabled USB 3.0 port on your PC
- WIDEsystem USB thumb drive supplied with your scanner
- Scanning software or compatible third-party software
- Grounded power outlet
- PC with USB 3.0 port or enabled Gigabit port



NOTE: Gigabit interface compatibility and speeds depend on your scanner model.

Installation step by step

1

Set up the scanner and stand (optional)

Your scanner should be placed on the specially designed stand-alone floor stand or on a sturdy table. Make sure there is enough space behind the scanner to allow the media to run out.



IMPORTANT: DO NOT CONNECT THE SCANNER TO THE POWER OR PC YET



See also the safety instructions at the end of this user guide

2

Install WIDEsystem and scan/copy software on your PC

! IMPORTANT: WIDEsystem contains the scanner driver and must be installed **before connecting the scanner** or installing any third-party scanner software.

- Insert the WIDEsystem USB drive into your PC and start the installer manually by double-clicking the setup file visible in the root
- Follow the instructions on screen to install the WIDEsystem software and scanner drivers. Reboot the PC when requested
- Remove the USB drive when the installation completes
- After successful installation the WIDEsystem icon will display in the pc system tray 
- Now install the scan and copy software from Contex or a third-party supplier
- Leave the PC switched ON ready to finish setting up the scanner

! IMPORTANT: During all installation steps, be sure to select “**YES**” if Windows asks you to allow the software to access the network.

! CAUTION: DO NOT CONNECT THE SCANNER TO POWER OR TO THE PC. This is to ensure your own personal safety and to help protect your device from potential damage during cleaning in the next steps.

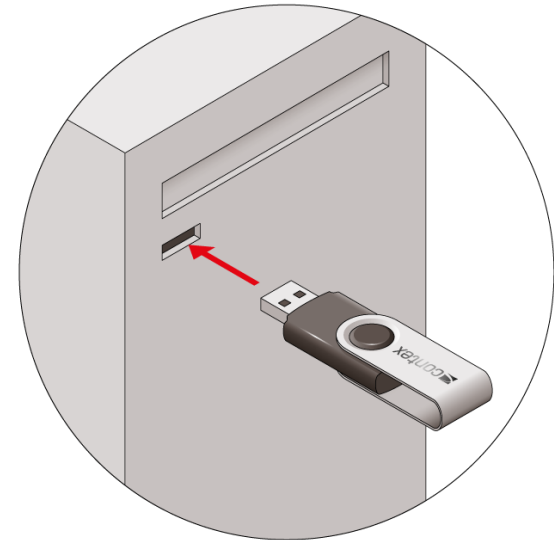

3

Clean the scanner feeding bed

This is the flat surface in front of the insertion slot. Wipe thoroughly so dirt and dust are not dragged into the scan area with the original.



4

Open the scanner lid by sliding the lid release buttons

The internal scan area should be wiped clean for any dust accumulated during packaging and shipping. The scan area is under the scanner lid so you have to open it. The lid release buttons are at the back of the lid.

- Stand at the front of the scanner
- Push down on the lid and simultaneously slide both release buttons towards the scanner's center with your fingers until you feel them unlock
- Use your other fingers to grip the edge of the lid



5

Raise the lid

Retain pressure on the lid release buttons and your grip on the lid edge as you pull the lid backwards towards your body. Open the scanner lid all the way back.

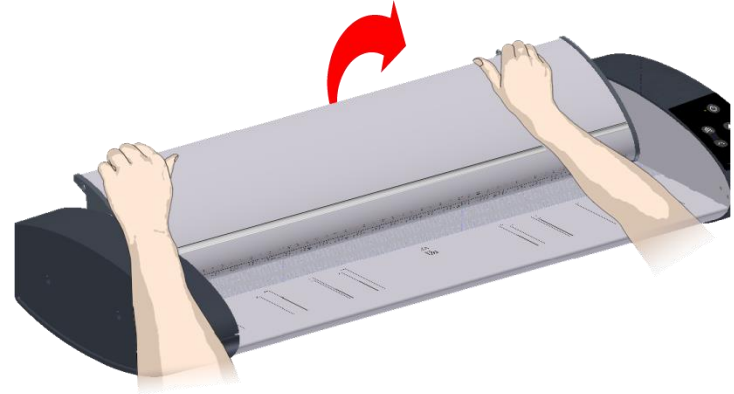

6

Clean the internal scan area

Wipe the internal scan area free of dust. Use a dry lint-free cloth.

If you detect smudges on the glass that cannot be wiped clean with a dry cloth, refer to the guide section [Cleaning the scan area](#) for instructions on thoroughly cleaning the scan area in connection with scanner maintenance.

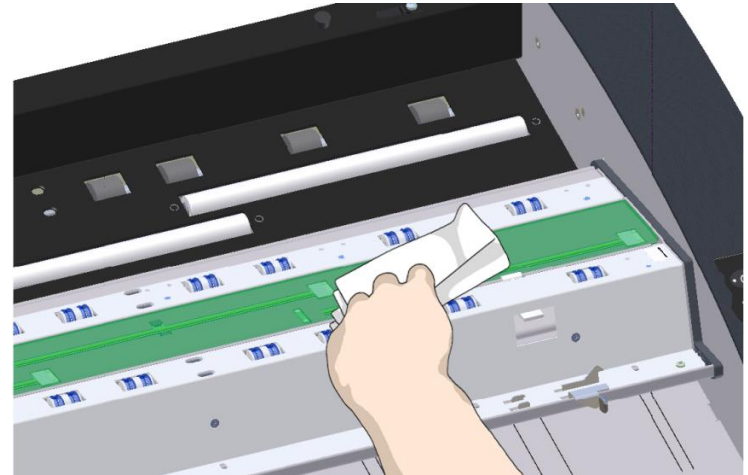

7

Connect the power cable to the scanner

Connect the scanner power cable to the scanner main power connection socket. The main power connection socket is on the back of the scanner.

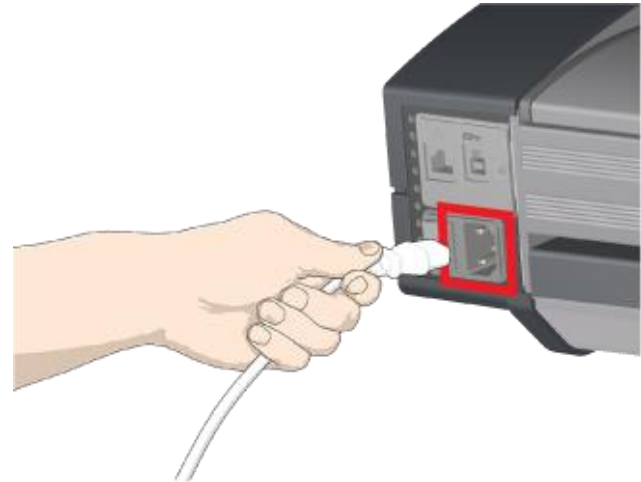

8

Connect power to the wall outlet

Connect the other end of the scanner power cable to the power outlet.

! **CAUTION:** The scanner is equipped with a three-wire (pin) grounding type plug. If you cannot insert the plug into your outlet, contact your electrician to replace the plug or outlet to ensure a grounded power connection. Do not try to defeat or ignore the purpose of the grounding-type plug.

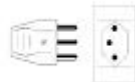

9

Turn on the scanner

Turn on the main power switch at the back of the scanner

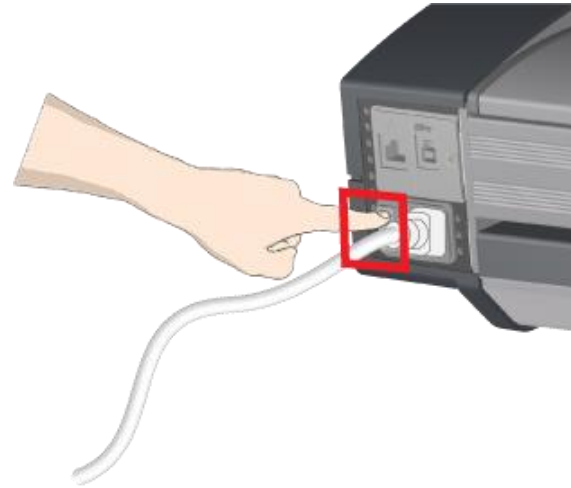

10

Connect the USB 3.0 interface cable

Initial installation and activation of the scanner is easiest using the USB 3.0 connection. This applies also for Gigabit enabled models.

- The cable connection area is found on the left as you view the back of the scanner
- Connect the B-connector end of the cable to the USB 3.0 port on the scanner (shown right)



NOTE: For Gigabit enabled scanner models: The installation wizard will instruct you on installation and activation of the gigabit interface **later** in the installation process. For now, simply connect the USB 3.0 cable.



Regulatory Notice: Your scanner product has been tested to comply with the EMC Standards EN55022 and FCC, Part 15. To maintain compliance, only use the interface cables supplied with the scanner.

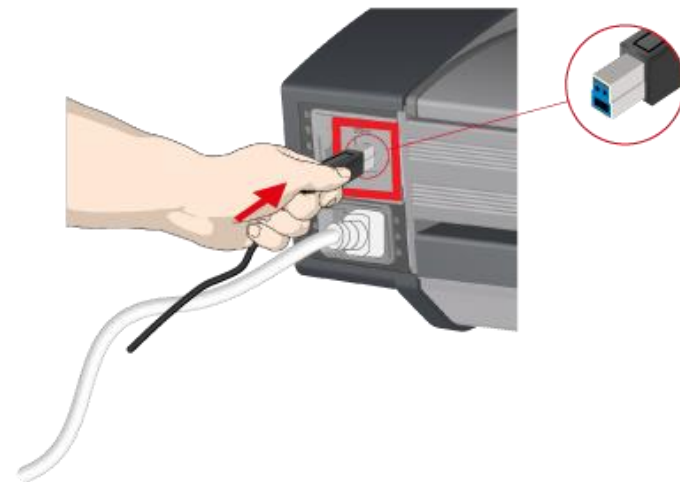

11

Connect the USB 3.0 interface cable to PC

- On the PC check that WIDsystem is running. The WIDsystem icon should be visible in your system tray 
- If WIDsystem is not running locate the WIDsystem entry under your *Programs* menu and start it manually
- Make sure the USB 3.0 cable is connected to the scanner
- Connect the A-connector end (flat end) to a USB 3.0 port on your computer



NOTE: It is recommended to use a USB 3.0 port on the **back** of the PC as front ports can sometimes cause speed problems.

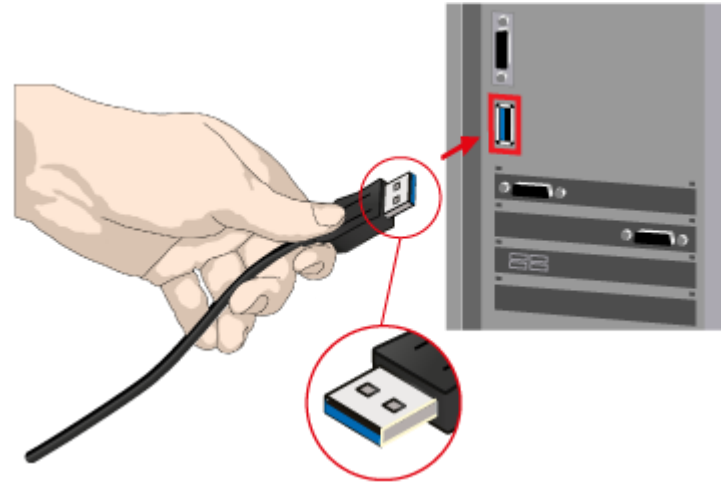

12

The Installation Wizard starts up

- The driver will detect the scanner and start the scanner installation wizard.
- On first time installations, the WIDsystem Scanner Installation Wizard should start after 20 seconds
- If the installation wizard does not start up, perform one or more of the following:
 - Unplug and reinsert the USB 3.0 connections to scanner and PC
 - Ensure the USB 3.0 cable is firmly inserted at both ends
 - Try a different USB 3.0 port on the PC
 - Make sure the USB cable is inserted into the port marked for USB 3.0 at the back of the scanner and not the Ethernet port

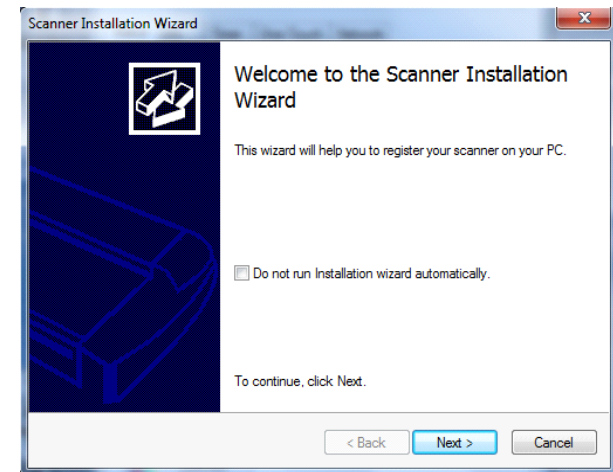

13

Windows installs the scanner

- Click Next and follow the instructions on your screen to install the scanner on your PC
- Most of the scanner installation process is automatic
- Wait until the completion message appears
- Press *Next* when done

 **IMPORTANT:** During the installation always allow the software to access the internet if Windows asks your permission.

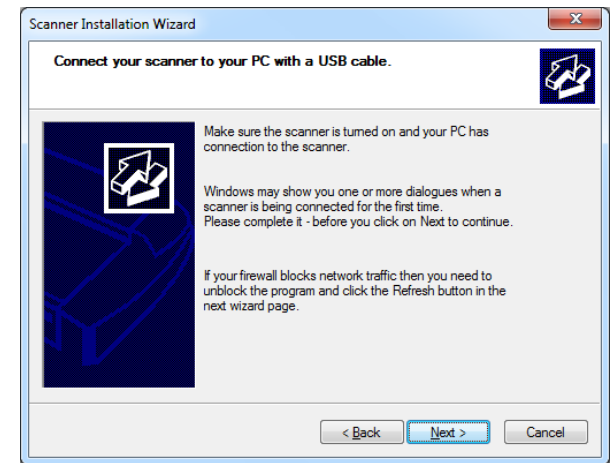

14

Set the Energy Star idle time

The scanner is factory set for automatic entry into sleep mode after a preset *idle* time, i.e. the length of time the scanner is not active. The default time period for Energy Star compliance is 15 minutes.

You can extend the time before this occurs up to a maximum of 60 minutes.

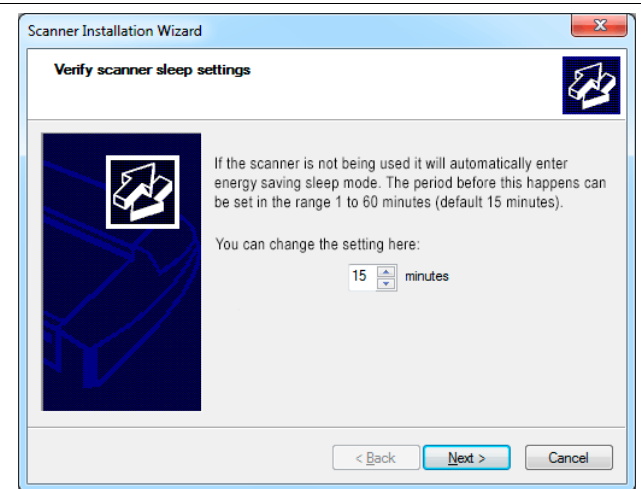

15

Activate the scanner

You must activate your scanner with its licence before you can use it. Please follow the *Scanner Activation Wizard* instructions.



NOTE: Your supplier may have pre-activated the scanner for you. If the scanner is pre-activated, the wizard will skip this step and following steps 16a, 16b.

About license keys and activation codes:

- You will need to enter your license key that came with the scanner
- Contact your dealer if you do not have a license key
- **Online** activation needs the license key but no activation code
- **Manual** activation needs a license key and an **activation code**. Activation codes can be obtained from your dealer or from the manufacturer Licensing website. Follow the instructions *Manual Activation* (below) to obtain an activation code from the Licensing website

To activate the scanner:

- Press the *Activate* button to start the activation wizard
- There are two ways to activate the scanner – *Online* and *Manual*
- If your PC is connected to the Internet choose **Online** activation, otherwise choose **Manual**
- If you chose *Online* proceed to the instructions in step 16a (and skip 16b). If you chose *Manual*, proceed to the instructions in step 16b (skip 16a)



IMPORTANT: During the installation always allow the software to access the internet if Windows asks your permission.

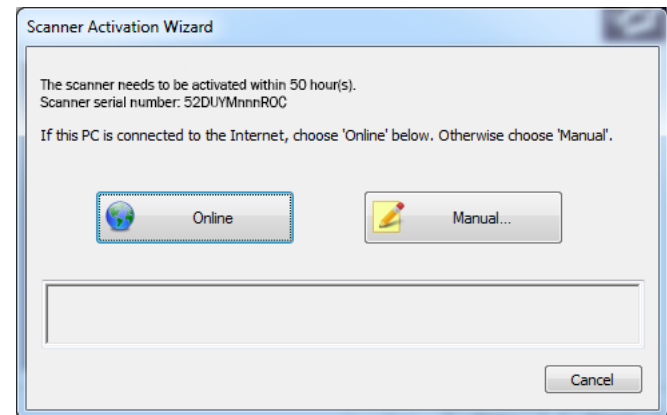
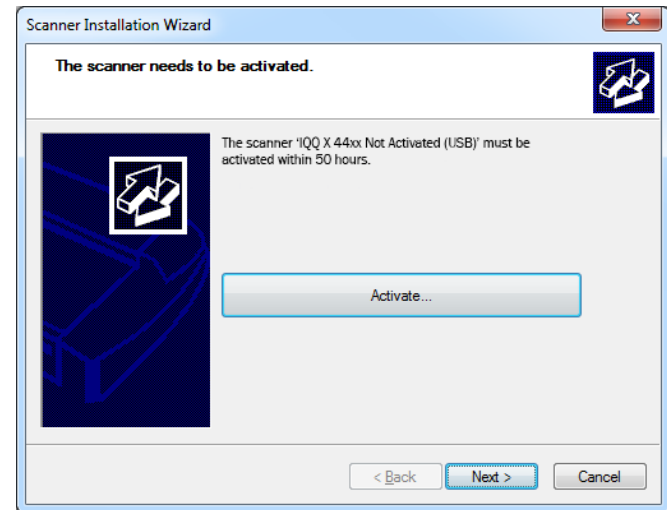

16

Online activation

Online activation is very easy. You only need your license key. When you choose *Online* as the activation method, the dialog shown on the top right appears.

- Enter your license key in the designated field
- A green tick will appear after the authentication check if the license is valid
- Press the *Activate* button to continue
- A *'Success'* banner indicates successful activation

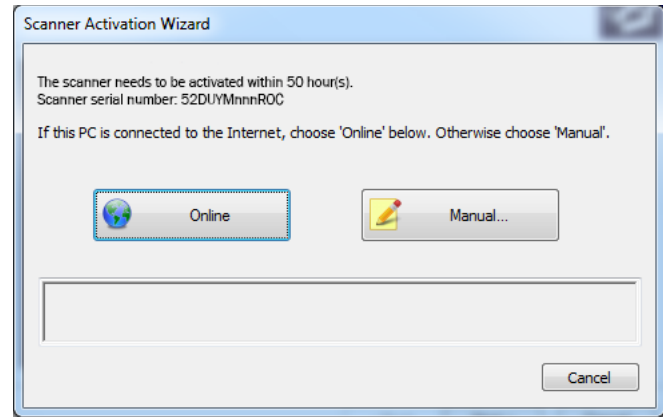
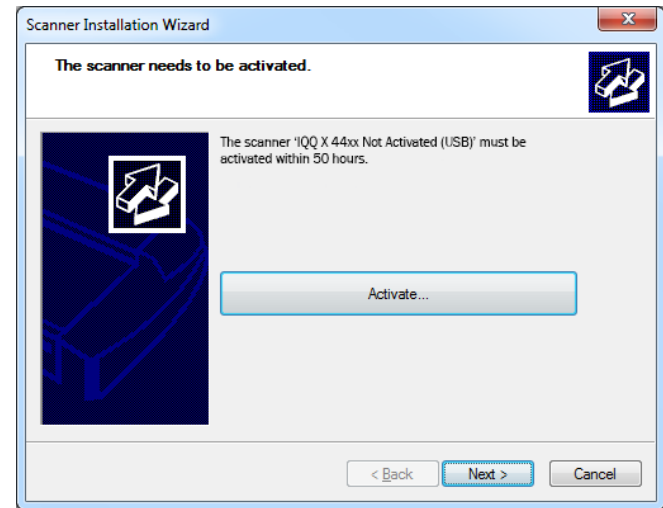

17

Manual activation

- Have your *license key* ready before proceeding. If you don't have one contact your dealer
- Manual Activation uses an *Activation Code* that requires the *scanner ID* (either a *serial number* or the *hardware ID*) and the *license key*. The *hardware ID* is read from the scanner and displayed automatically by the pc wizard (*1) during the manual activation process
- You will need internet access (from any device) to process the *license key* and *scanner ID* to build the *activation code*

Follow the instructions below (repeated in the wizard):

- Write down or copy the *hardware ID* displayed by the wizard (*1). You will need to transfer both of these to the online activation form
- Go to www.licenseactivate.com
- In the *License Activation* web form enter the scanner *serial number* (see label on back of scanner) or the *hardware ID* (from the wizard in step *1)
- Now enter your *license key* into the second field. Click the *Activate* button to generate the *Activation Code* (*2)
- Note down or copy the *Activation Code* from the web form (*3)
- Type in or paste the *Activation Code* into the Manual Scanner Activation wizard dialog (*4). Press *Activate* then press *Next*
- The wizard will now activate the scanner. When complete a success message will be displayed

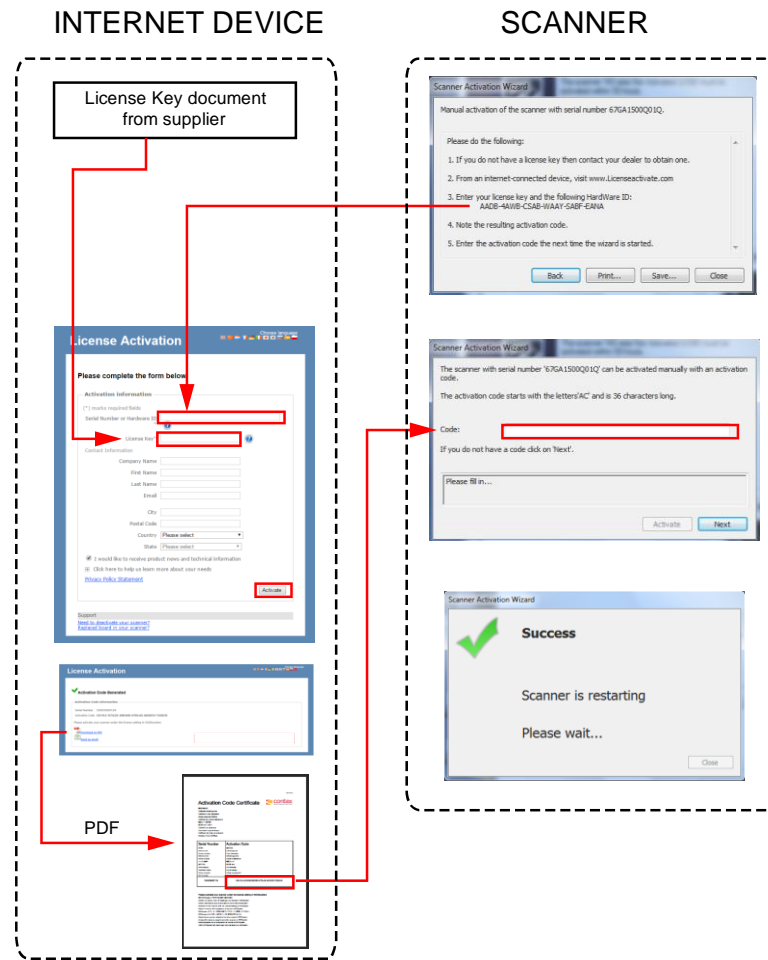

18

Scanner calibration

Calibration is initiated automatically as part of the scanner installation.

- Press *Calibrate* to start the wizard
- Follow the wizard instructions to perform scanner calibration
- If you did not clean the internal scan area and glass as instructed in the previous installation steps do so now
- You will be asked to insert the calibration sheet that came with the scanner
- Be sure to align the sheet arrow with the scanner middle arrow.
- Press the Full Calibration button (automatic process)
- The wizard will notify you when the calibration completes successfully 
- After completion remove the calibration sheet
- See the *Scanner Maintenance and Calibration Guide* for more information

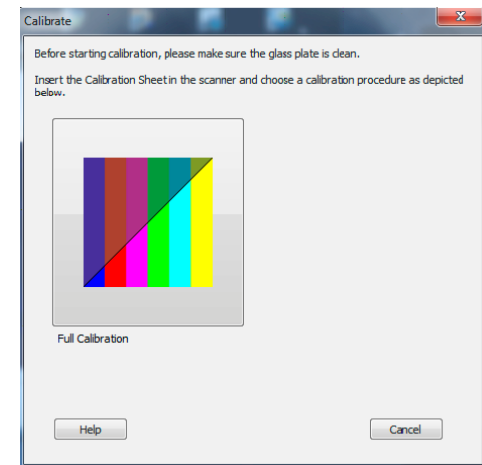
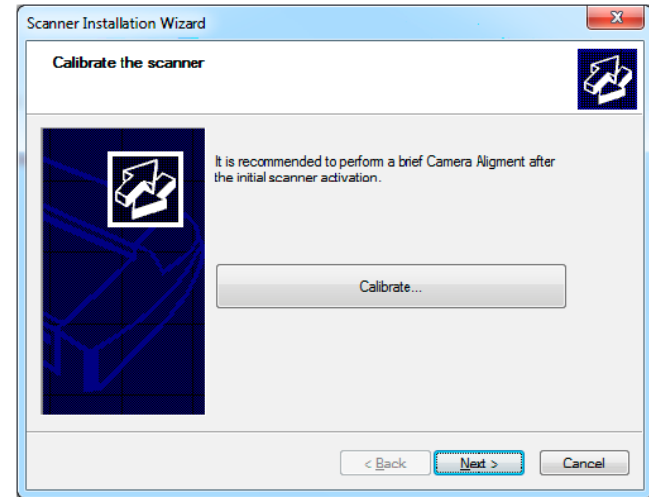

19

Installation complete

The scanner has been installed correctly when you see this message.



NOTE: Scanner connected using USB 3.0

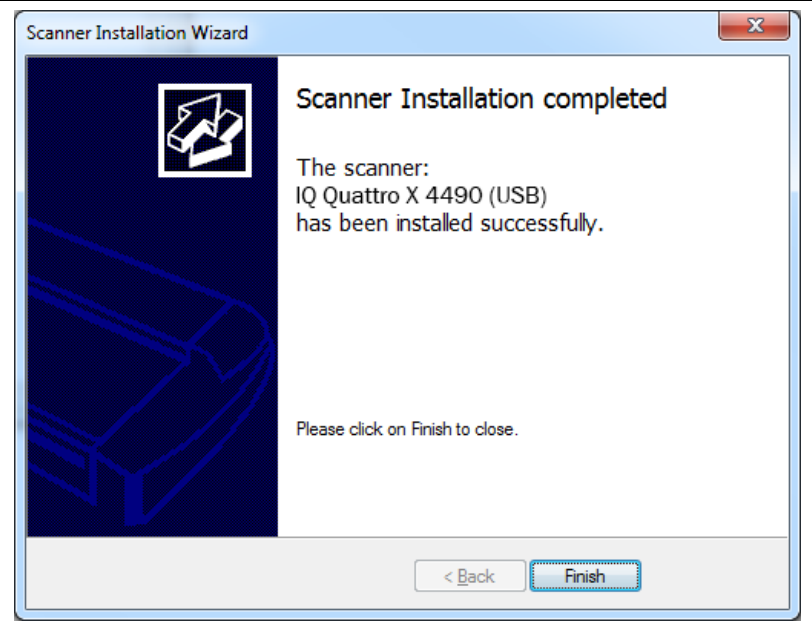

20

Using the scanner on a network (Ethernet)

First switch off the scanner.

If connected remove the USB 3.0 cable from the scanner. Insert one end of the supplied Ethernet network cable into the gigabit network socket on the scanner. Now connect the opposite end of this cable to the network. Switch on the scanner.

The WIDsystem icon will be gray.

- Double-click or right-click the WIDsystem icon to start WIDsystem
- Click the refresh button in case an unknown scanner is on the network 
- The interface will display 'No scanners found'
- Click the Network tab
- Select 'Add...' from the scanner drop down list or click the Add button in the network scanner area to begin adding the scanner to the network



NOTE: The 'Remove...' button will delete the entry for a removed scanner (grayed). It can also be used to remove a scanner before reinstalling again if changes are made to the network or the scanner and the scanner is not reconnecting.

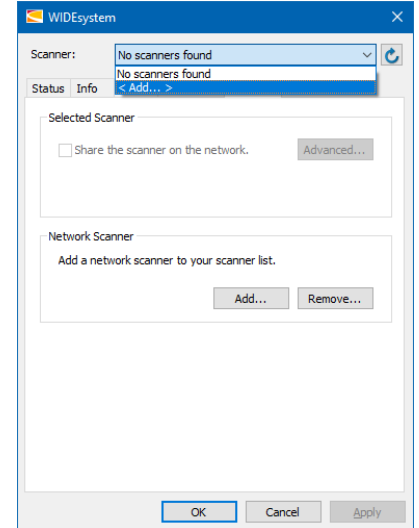
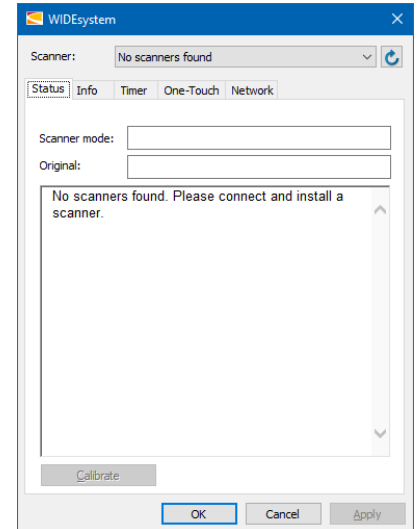

21

Checking the firewall

The scanner installation wizard launches

- Click Next
- The firewall settings of some Windows computer installations may prevent or block WIDEsystem from locating the scanner. If you think this might be happening ask your IT administrator to check the firewall settings on the computer being used.
- Check the scanner is switched on and ready to connect by feeding a piece of paper into the feed tray
- Click Next to proceed

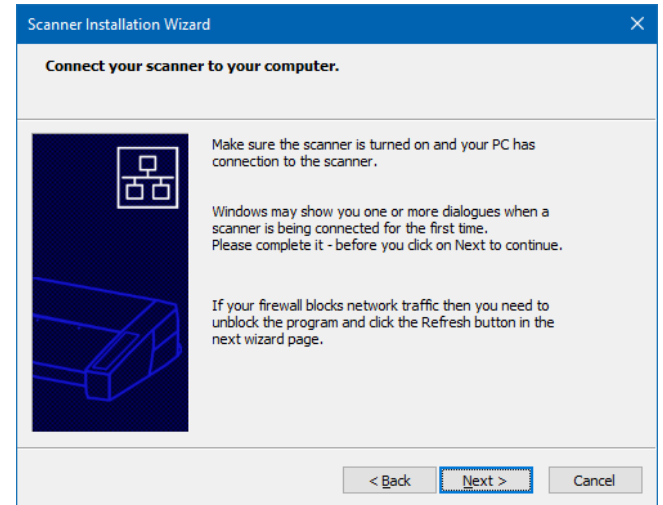
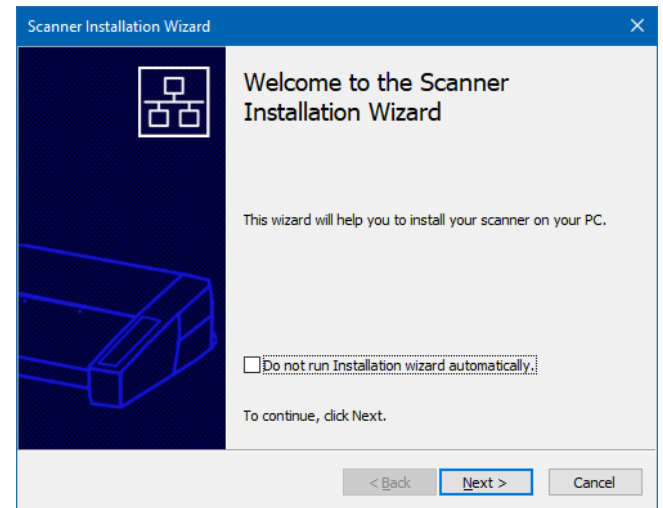

22

Selecting a networked scanner

The scanner selection window appears

- New network scanner(s) that are available will be shown highlighted in blue
- Select the scanner
- Click Next
- WIDEsystem confirms connection and displays the scanner serial number
- Click Finish



NOTE: Scanners already installed on the same network will appear grayed and cannot be selected.



NOTE: Always ensure you have the latest WIDEsystem version installed or your scanner may not be detected

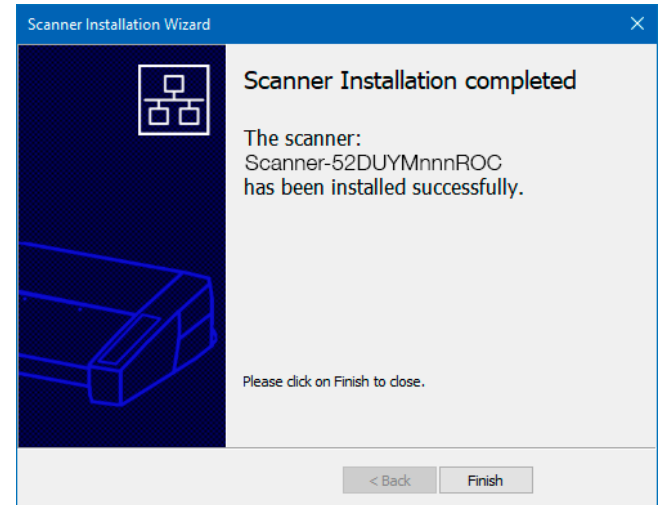
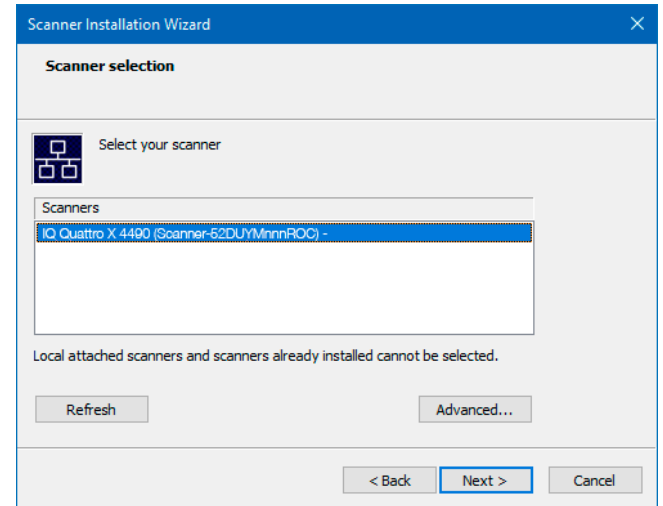

23

Removing a networked scanner

Disconnected or old scanners that remain in the scanner list can be removed using WIDEsystem

- Double-click or right-click the WIDEsystem icon
- Click the Network tab
- Click the Remove button
- Choose the network scanner to remove
- Click OK to remove it



NOTE: If a networked scanner is removed accidentally return to the Network tab and click Add to re attach it.

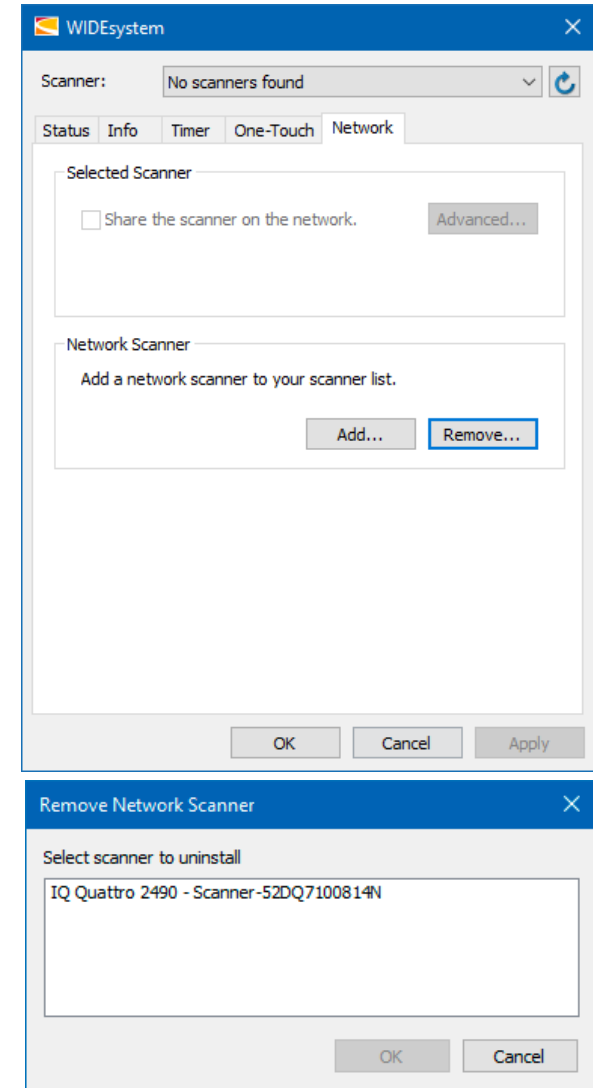

24

Changing scanner network settings

In the system tray double-click the WIDeSystem icon or right-click it and select Restore WIDeSystem from the menu.

Ensure the WIDeSystem icon is yellow which indicates the scanner is connected.

Select the Network tab

Click the Scanner Setup button

The scanner setup window has options to change the:

- scanner network (host) name
- network port numbering
- type of IP addressing (default is DHCP)



NOTE: Contact your network administrator if you need help with the above

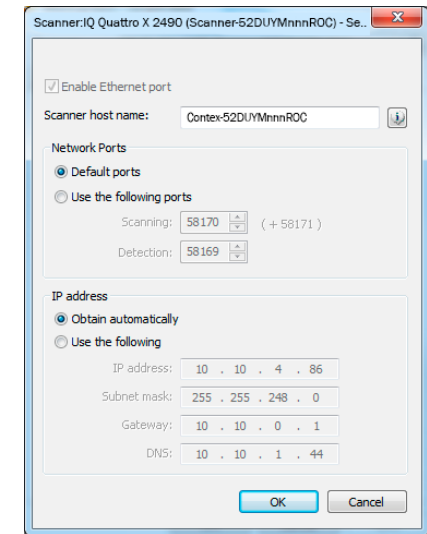
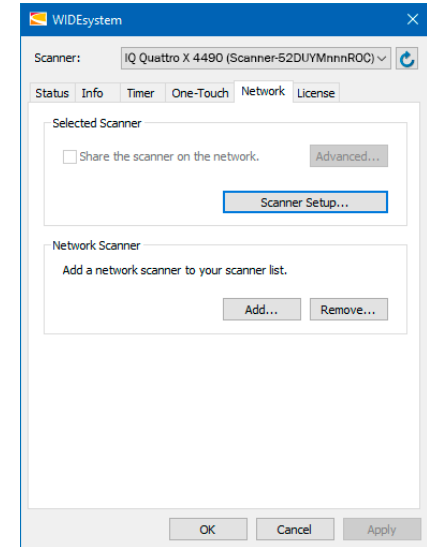

Main power switch

The main power switch is at the back of the scanner. Press the left side of the switch (marked "I") to turn the main power to ON. Press the right side of the switch (marked "0") to turn the main power to OFF.

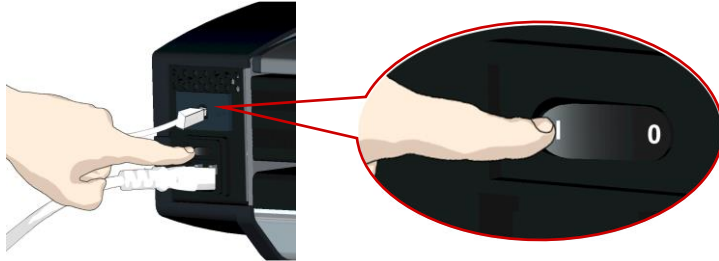

Main power switch is at the back of the scanner. Press "I" for ON and "0" for OFF.

Self-test procedure

When you turn the main power ON the scanner will run a short self-test that takes less than a minute. The LEDs on the panel will light during the self-test.

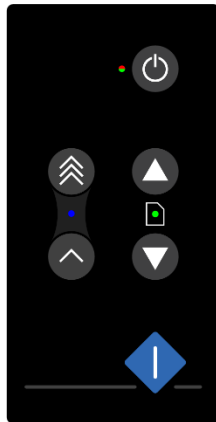

All LEDs are on during self-test.

Scanner ready to scan

The scanner is ready for scanning when the power LED turns green. The scanner starts up in *Wake* mode (see next section).

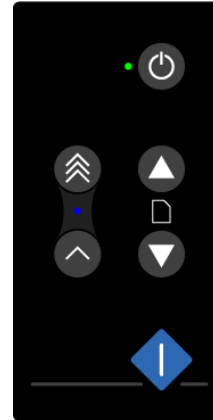

Scanner ready – in *Wake* mode.

You can leave the main power switch permanently ON and control scanner power through its **Sleep** and **Wake** modes.

Sleep and wake modes

With the main power switch ON, scanner power can be set in *Sleep mode* and *Wake mode*. **Sleep** mode is the energy saving mode. The scanner cannot scan when in the *Sleep* mode. **Wake** mode is the full power ON mode for scanner operation.

The scanner will go from *Wake* mode into **Sleep** mode:

- Automatically: After a set idle time (see [Sleep mode options](#) below)
- Manually: When you hold the power button down for 3 seconds



Hold down the power button to enter Sleep mode.

Scanner in Sleep mode – power LED is yellow.

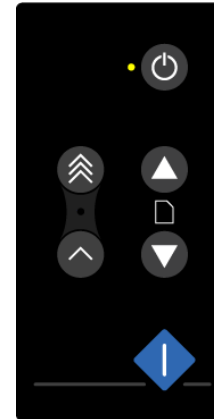

The scanner will go into Wake mode (green led) from Sleep mode:

- *When you feed a document into the scanner*
- *When you press the power button*

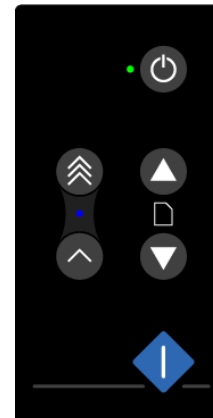

Scanner in Wake mode – power LED is green.

Automatic shut down after idle time

The scanner is factory set for automatic entry into sleep mode after a preset default idle time, i.e. the length of time the scanner is not active. You can prolong or shorten the idle time value to match your normal workflow.



NOTE: You will normally be prompted to change the idle time during installation. You can omit this step unless you wish to reset it.

To change/set the sleep mode options:

- Open WIDEsystem - double-click the WIDEsystem icon  in the system tray
- Select the *Timer* Tab
- If you want to put the scanner into sleep mode before the time set in this option use the manual method for entering sleep mode
- Set the value *Idle time before entering sleep*. This is the number of minutes the scanner can stand idle before entering the sleep mode on its own
- Press *Apply* to download your settings into the scanner's memory

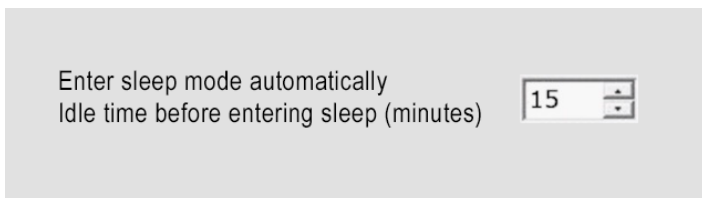

Sleep Mode options in the WIDEsystem program – Timer tab



NOTE: The automatic waking and sleeping modes can be activated manually using the power button.

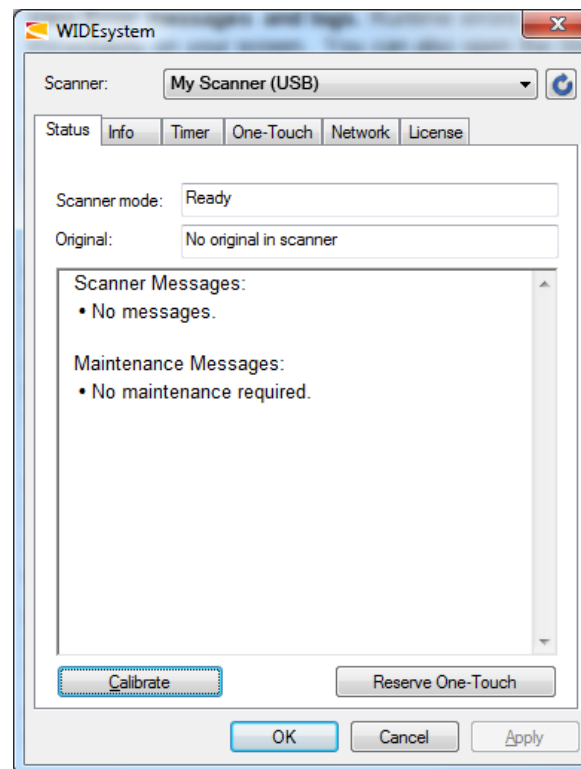

- **Wake** - Press power button on the panel or insert a document.
- **Sleep** – Press and hold down the power button for 3 seconds.

Load face-up in the center of the scanner

- Load your document with the image side facing upwards. Align the center of the document with the center arrow marking on the scanner bed
- Use the standard paper size markings to center and square up the document for a straight scan path



You can choose [automatic loading](#) or [manual loading](#) in the scanning software.



NOTE: The availability of the *automatic* and *manual* loading options will depend on your scanning software and its level of compatibility with the scanner model.



Load the paper face-up. Hold it using both hands and align the document center with the center marking on the scanner.

Automatic loading

With **automatic loading**, the scanner takes the original as soon as you insert it in the paper slot. Automatic loading is reliable for most jobs and especially useful for batch scanning jobs.

- Make sure the Paper handling option “*Auto load*” is set in your scanning application
- Align the center of the document with the center arrow marking on the scanner bed

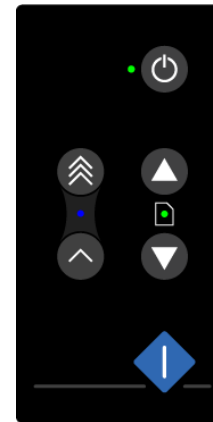

- The paper ready LED will light up green just before the paper feeds
- Push the original into the insertion slot until you feel it contact the rollers and the Paper Ready LED lights green
- The scanner will take hold of the original automatically and move it into the start-scan position
- The amount of time the scanner waits for the operator to correctly position the document can be adjusted in the scanning software. This is useful if the scanner is taking the original too quickly

Manual loading

- Make sure the Paper handling option “*Manual*” is set in your scanning application.
- Align the center of the document with the center arrow marking on the scanner bed.
- Push the original into the insertion slot until you feel it contact the rollers and the Paper Loaded LED lights up green.
- While holding the original in place with one hand, use the other hand to press and hold down the Paper Forward button on the scanner.

When the Paper Loaded LED turns green – press the Paper Forward button.



The original will move into the start-scan position.

Unloading the original after the scan

- Press the Paper Backward button to eject the original back towards you

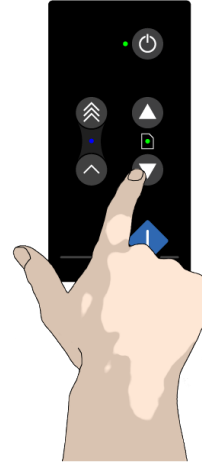

- Press the Paper Forward button if you wish to eject the original away from you



Soft handling

The *soft-handling* option can be selected in your scan application. Soft-handling means that feeding and scanning are slowed down. You can use the option with both *Manual* and *Automatic* loading.



NOTE: The availability of the soft handling load option depends on your scanning software and its level of compatibility with the scanner model.

Use *soft-handling* for:

- Old, curled or creased originals that trigger a paper jam. See Paper Jam error in the Trouble Shooting section for correcting a paper jam error.
- Fragile originals that you need to be handled more delicately through the scanner drive system.

Setting the input size

The scanning software input size dialogue defines the area to be scanned.



NOTE: The exact choice of *input size* options will depend on your scanning software and its compatibility with the scanner.

There are at least three ways to control the input size:

- **Use automatic size detection** - The scanner will detect the edges of the document and calculate the input size for you.
- **Set a standard size** - Common standard paper sizes are marked on the scanner bed. Use these markings to determine which standard size matches the original and then select that size in the software *input size* dialog.
- **Set the size manually** – For irregular paper sizes. Measure the document with the inch/cm ruler on the scanner bed. Enter the width measurement in the *width* setting field in the software *input size* setup dialog. You can also measure and set a *length* value or choose automatic length detection.

Scanning software

Your scanner is controlled through scan, copy or imaging software installed on your PC.

Optimal full featured scanning functionality is obtainable through scan and copy software specifically developed for compatibility with your scanner model. See the scanner manufacturer website for information on scanner software and compatible third-party applications.

Batch scanning

Batch scanning involves jobs where you want to feed and scan a whole set of originals that require equal scan settings. The basic steps are:

- Set your scan settings (size, type, image adjustments) for the batch. Your settings will apply to ALL the documents in the batch.
- Set the scan software into *Batch Mode*. This will tell the scanner to start scanning as soon as the document is fed so you don't need to trigger the scan.
- Choose [Automatic loading](#) (optional) for fast and effective loading. Read your scan software on-line help pages for specific information on batch scanning with the application.



NOTE: The choice of batch scanning options will depend on your scanning software and its compatibility with the scanner model.

Monitoring your scanner with WIDEsystem

WIDEsystem is software that controls and continuously monitors the health of the scanner. Double left-click the system tray WIDEsystem icon to open the WIDEsystem control interface. 

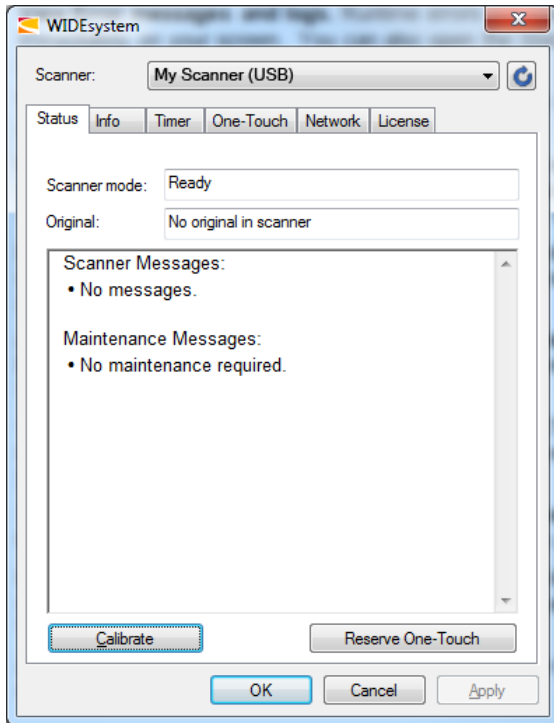

WIDEsystem front screen



Scanner status message on Windows system tray

- **Obtain scanner status** by moving the mouse over the WIDEsystem icon. A grayed icon indicates a sleeping or disconnected scanner
- **View Error messages and logs.** Runtime errors appear on screen. See the *Status* and *Log* tabs for error messages
- **View information about the scanner** firmware and hardware revisions by opening the *Info* tab
- **Install new firmware** by downloading new firmware to a folder on the connected computer. Right-click the scanner icon and select *Advanced Options > Update Scanner Firmware*
- **Reset the computer connection** by right-clicking the scanner icon and selecting *Advanced Options > Rescan Hardware Bus*
- **Set up your scanner for sharing by others on the network** by using the *Scan to Net* tab
- **Set up your scan software so it can access shared scanners on the network.** Click the *Scan to Net* tab
- **Launch the WIDEsystem online help** for instructions on troubleshooting and using WIDEsystem by pressing the F1 key
- **Activate and upgrade your scanner** by opening the *License* tab and entering a valid license or upgrade key
- **Launch the scanner calibration wizard** by right-clicking the scanner icon and selecting *Calibrate*

About scanner maintenance

Scanner maintenance will ensure the best performance of your scanner. There are three basic maintenance tasks.

- **Cleaning**

This section describes how to thoroughly clean the internal scan area. How often you need to clean will depend on how often and the types of media you scan. If your work primarily involves scanning newspapers and old blueprints you may need to clean more often than users who only scan brochures and new drawings. Be sure to clean the scanner when results start to degrade. Particles of dust in the scan area can sometimes be the sole cause of streaks in the end result. See more under the section [Cleaning the scan area](#)

- **Calibration**

Calibrate the scanner if your output is degraded but cleaning (above) has not solved the problem. Calibration will renew the original colors and precision of BW work. Scanner calibration is started by inserting the calibration sheet and starting the scanner maintenance program. It is extremely important to make sure the scanner is clean before calibrating. See more under the section [Calibration Scanner Maintenance program](#).

- **Replacing the glass plate**

This should be carried out when a worn glass plate starts to affect scanned output. You may need a new glass plate if streaks still appear on the image even after cleaning the glass. See more under the section [Replacing the glass plate](#).

Cleaning the scan area

How often you clean your scanner will depend on how much you use the scanner and the condition of the documents. As a guide clean the scanner at least once a month and always before important jobs that require a high precision.

Clean the following scanner parts or areas:

- The scanner bed or feed tray area
- Glass plate
- Upper precision rollers
- Lower pressure rollers
- Lower rubber transport rollers



NOTE: To help locate these parts on the scanner, see the [Overview of key maintenance points and cleaning](#) on the next page.

How to clean the parts inside the scanner

Here is the scanner seen from above with its lid open showing the key parts and areas inside important for cleaning. The number of rollers and lid-release catches will be different for different sizes of scanner.

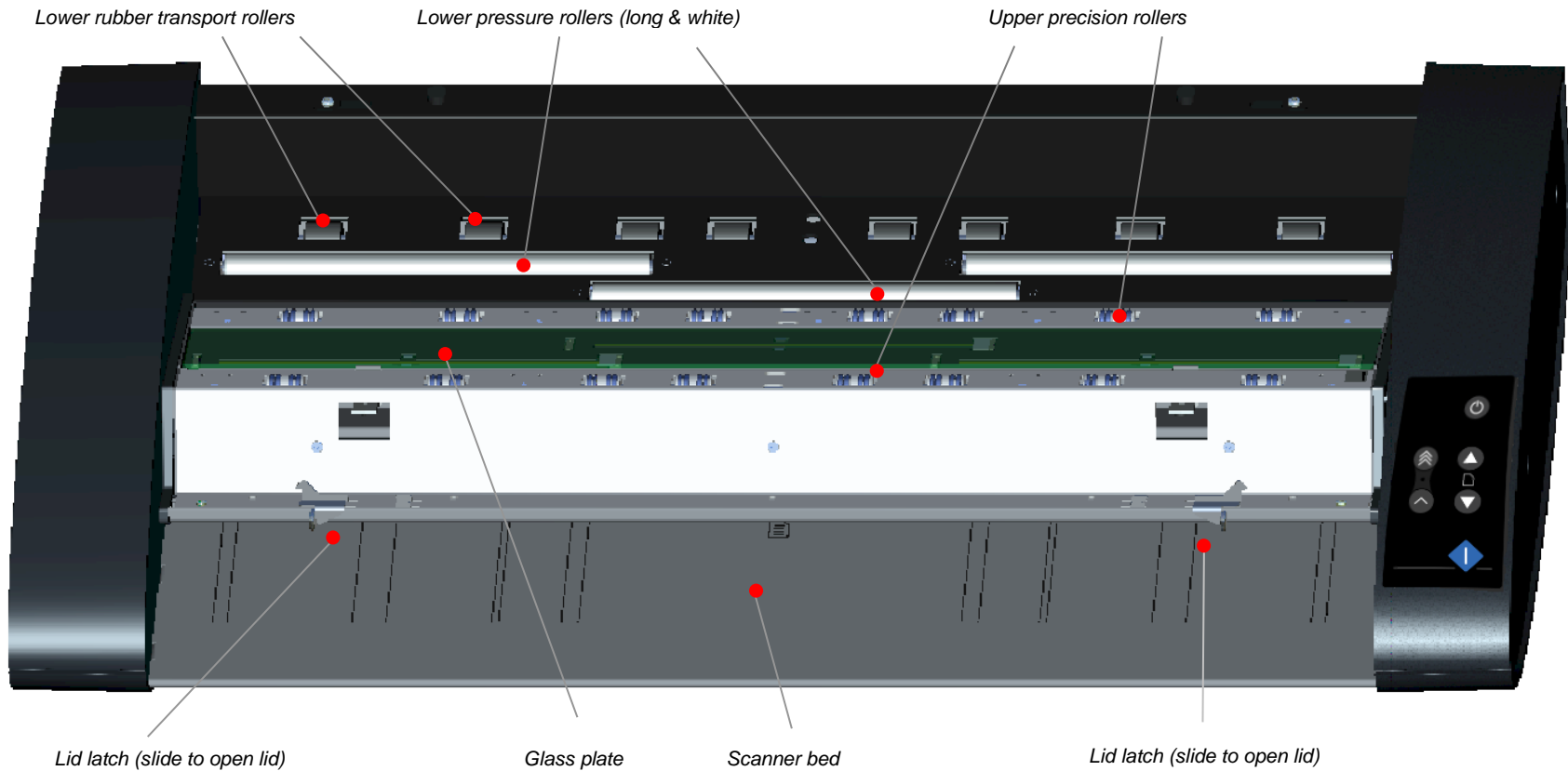

To clean your scanner:

1

Turn the main power to OFF

Press the main power switch at the back of the scanner to the OFF position ("0").

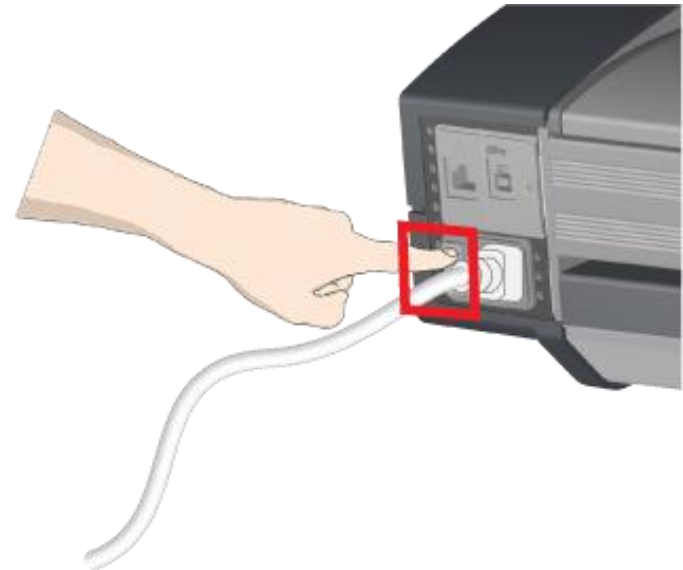

2

Disconnect the scanner power plug

! **CAUTION:** Always disconnect power before cleaning the scanner. This is to ensure your own personal safety and to help protect your device from electrical damage.

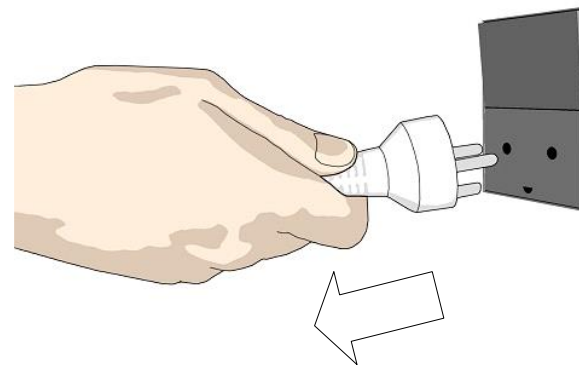

3

Clean the scanner surface

Clean the flat surface of the scanner so that dirt and dust are not dragged into the scan area with the original during scanning.



4

Open the scanner lid by sliding the lid release latches

Next open the scanner lid using the release latches at the back of the lid.

- Stand at the front of the scanner
- Push down on the lid while at the same time sliding both release latches towards the center of the scanner until you feel them unlock
- Use your other fingers to grip the edge of the lid



5

Open the scanner lid

Keeping pressure on the lid release latches pull the lid upwards toward your body. Now continue rotating the lid until it is laying upside down on the feed tray.

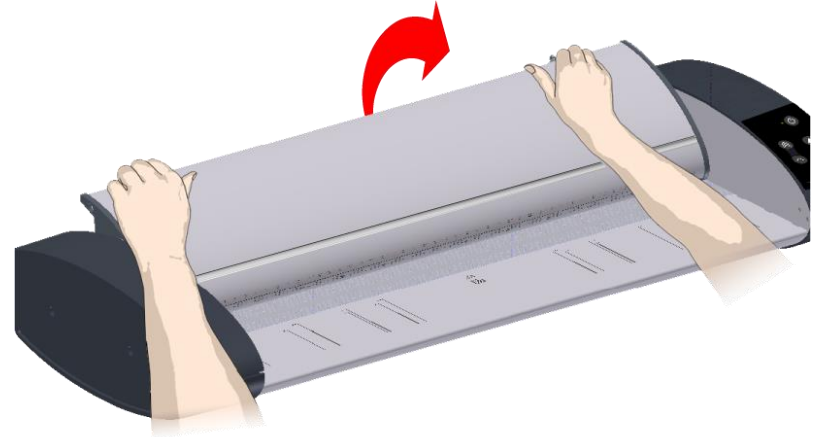

6

Clean the scanner glass plate

Make sure you use two fresh and clean lint-free cloths for cleaning the glass plate. Do not reuse the cloth you used to wipe the scanner bed.

- Spray/apply a mild, streak-free, glass cleaner onto a lint-free cloth
- Gently wipe the glass clean
- Dry the glass completely using the other clean, dry lint-free cloth
- Make sure that fluids do not get under the glass and that you leave the area dry



CAUTION: Do not spray/apply cleaner fluids directly on the glass plate or anywhere else in the scan area.



7

Clean the upper precision rollers

The lid upper precision rollers are arranged in two rows each side of the glass plate and keep the document moving in a straight line. These rollers are in direct contact with the color side of documents and may become quite dirty.

- Spray/apply a mild, streak-free, glass cleaner onto a lint-free cloth
- Gently wipe the surface of the rollers
- Use the cloth to turn the rollers so you wipe all sides
- Dry the rollers completely using another clean, dry lint-free cloth
- Make sure that you leave the area dry

 **CAUTION:** Do not spray/apply cleaner fluids directly onto the rollers or anywhere else in the scan area.

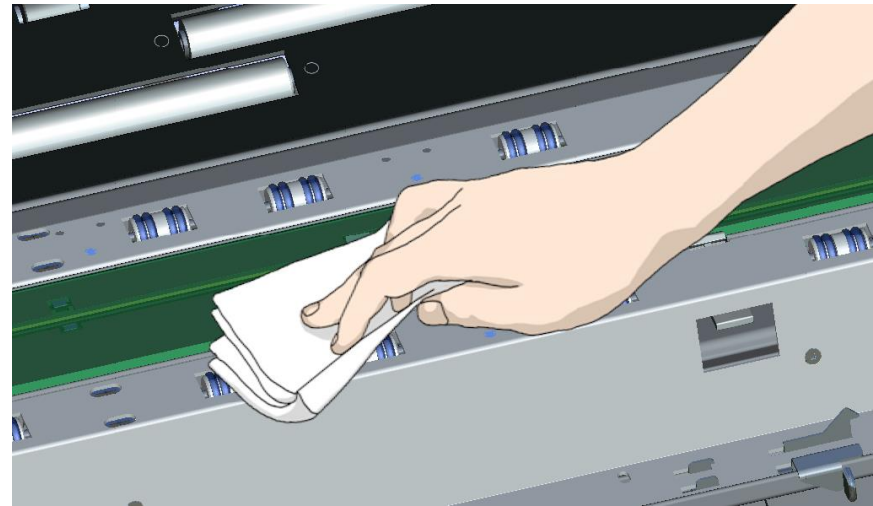

8

Clean the white pressure rollers

The long white rollers between the transport rollers in the base of the scanner keep the document flat as it goes through the scanner.

- Spray/apply a mild, streak-free, glass cleaner onto a lint-free cloth
- Gently wipe the surface of each white roller
- Use the cloth to turn the rollers so you wipe all sides
- Dry the rollers completely using another clean, dry lint-free cloth
- Make sure that you leave the area dry

 **CAUTION:** Do not spray/apply cleaner fluids directly onto the rollers or anywhere else in the scan area.

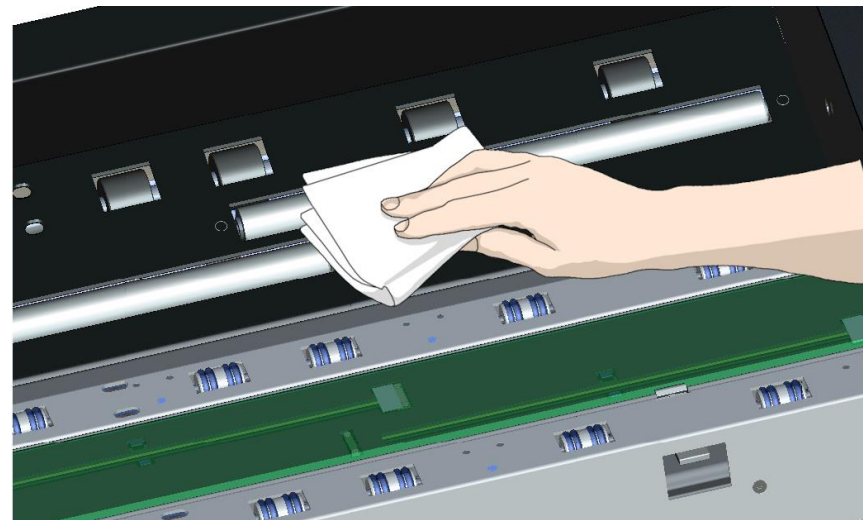

9

Clean the transport rollers

The two rows of powered transport rollers each side of the white pressure rollers in the base of the scanner rotate to drive documents through the scanner.

- Spray/apply a mild, streak-free, glass cleaner onto a lint-free cloth
- Gently wipe the surface of each roller
- Use the cloth to turn the rollers so you wipe all sides.
- Dry the transport rollers completely using another clean, dry lint-free cloth.
- Make sure that you leave the area dry.



CAUTION: Do not spray/apply cleaner fluids directly to the rollers or anywhere else in the scan area.



10

Close the lid

- Push the scanner lid down until you hear the lid latches “click”.
- Gently try to pull open the lid to ensure it is properly locked both sides.
- Plug in the scanner and turn the main power switch to ON.

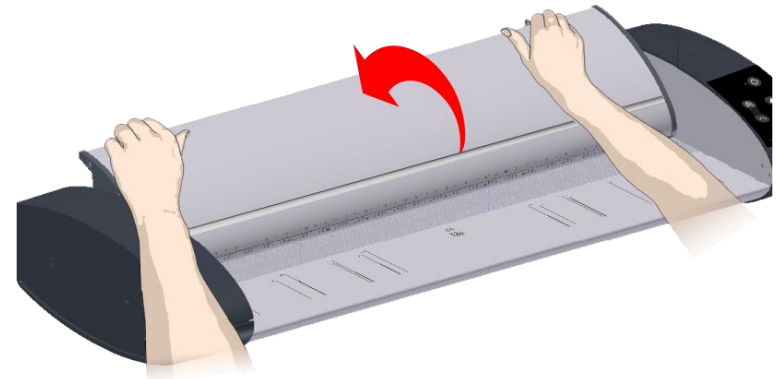

11

Your scanner is now clean

You have completed the steps required for cleaning your scanner and the scan area. Replace the rear paper guides and two paper tray magnetic guides as required.



Calibration

Scanner calibration is a mostly automatic process and carried out using the *WIDEsystem* program that was installed as part of the initial scanner installation.



NOTE: It is very important that the scanner feed area and glass are completely clean before calibrating.

To calibrate your scanner:

12

Turn the scanner power ON

If the main power is OFF, press the main power switch at the back of the scanner to the ON position. If the scanner is in *Sleep* mode press any button to set it in *Wake mode*.

The scanner is ready for calibration when the power LED lights green.

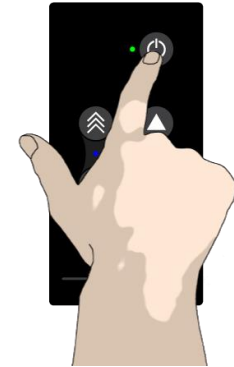
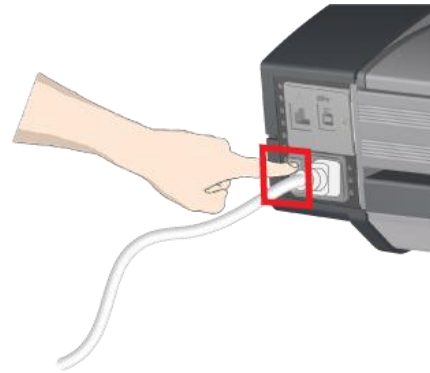

Calibration

13

Launch the scanner calibration wizard

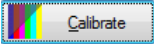
- Click the WIDEsystem icon  in the system tray to open the WIDEsystem program.
- Press the Calibrate button. 

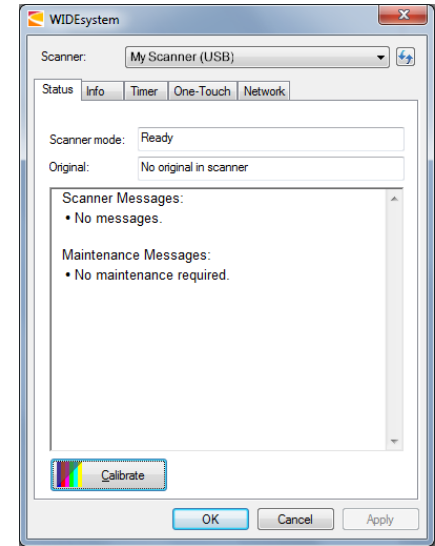

Calibration

14

Choose the calibration

Select either camera alignment or full calibration

- Camera alignment will align horizontal capture for correct image stitching
- Full calibration will perform camera alignment and B&W and color calibration

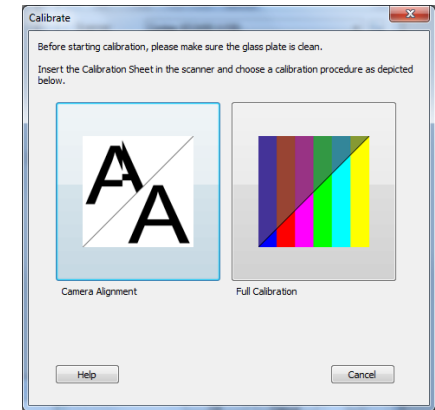

15

Insert the calibration sheet

The software wizard will ask you to insert the calibration sheet that came with your scanner.



NOTE: The printed side of the sheet must be inserted **face up** into the scanner **arrow edge first**.



Calibration

16

Scanner calibration

The program works in steps to analyze and correct the status of the sensors, calibrate black and white values and calibrate color (on color scanners). The calibration sheet will be rescanned a number of times as the program processes data.

Let the program complete the calibration steps you requested (Alignment or Complete).

The wizard will tell you when the process is finished.

After calibration:

- Remove the scanner calibration sheet from the scanner
- Return the scanner calibration sheet to its protective tube or folder
- Store in a dry place and out of direct light

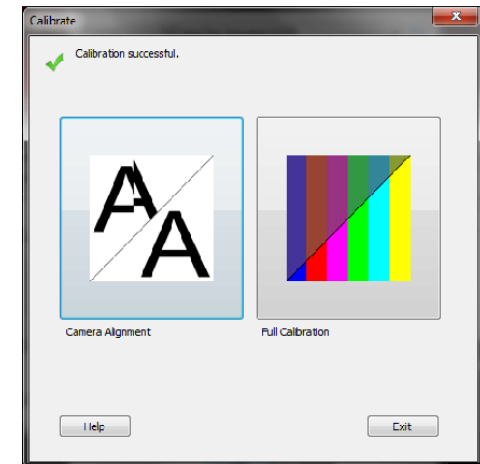

Replacing the glass plate

Over time, documents moving against the glass plate will cause it to wear and image capture quality may start to be affected. If this happens a replacement glass should be fitted to restore peak scanner performance.

To replace a worn glass plate:

17

Turn the main power to OFF

Press the main power switch at the back of the scanner to the OFF position.

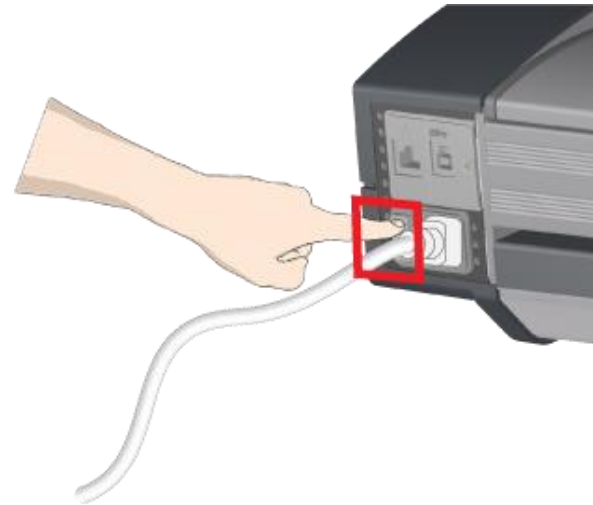

18

Disconnect the scanner power plug

! **CAUTION:** This step is to ensure your own personal safety and to help protect your device from potential damage.

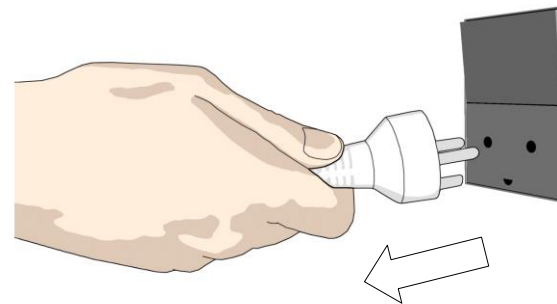

19

Open the scanner lid by sliding the lid release latches

Next open the scanner lid using the release latches at the back of the lid.

- Stand at the front of the scanner
- Push down on the lid while at the same time sliding both release latches towards the center of the scanner until you feel them unlock
- Use your other fingers to grip the edge of the lid



20

Open the scanner lid

Keeping pressure on the lid release latches pull the lid upwards toward your body. Now continue rotating the lid until it is laying upside down on the feed tray. See the [overview of key parts](#) below.

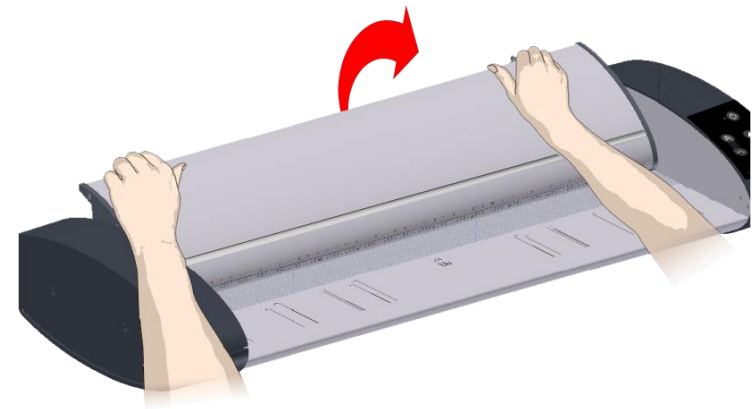

How to replace the scanner glass plate

Here is the scanner seen from above with lid open showing parts and areas important when replacing a worn glass plate. The glass plate is locked in place by several white latches. Press down the latch release buttons to release the glass plate (see below). The number of latches will be different for different sizes of scanner.

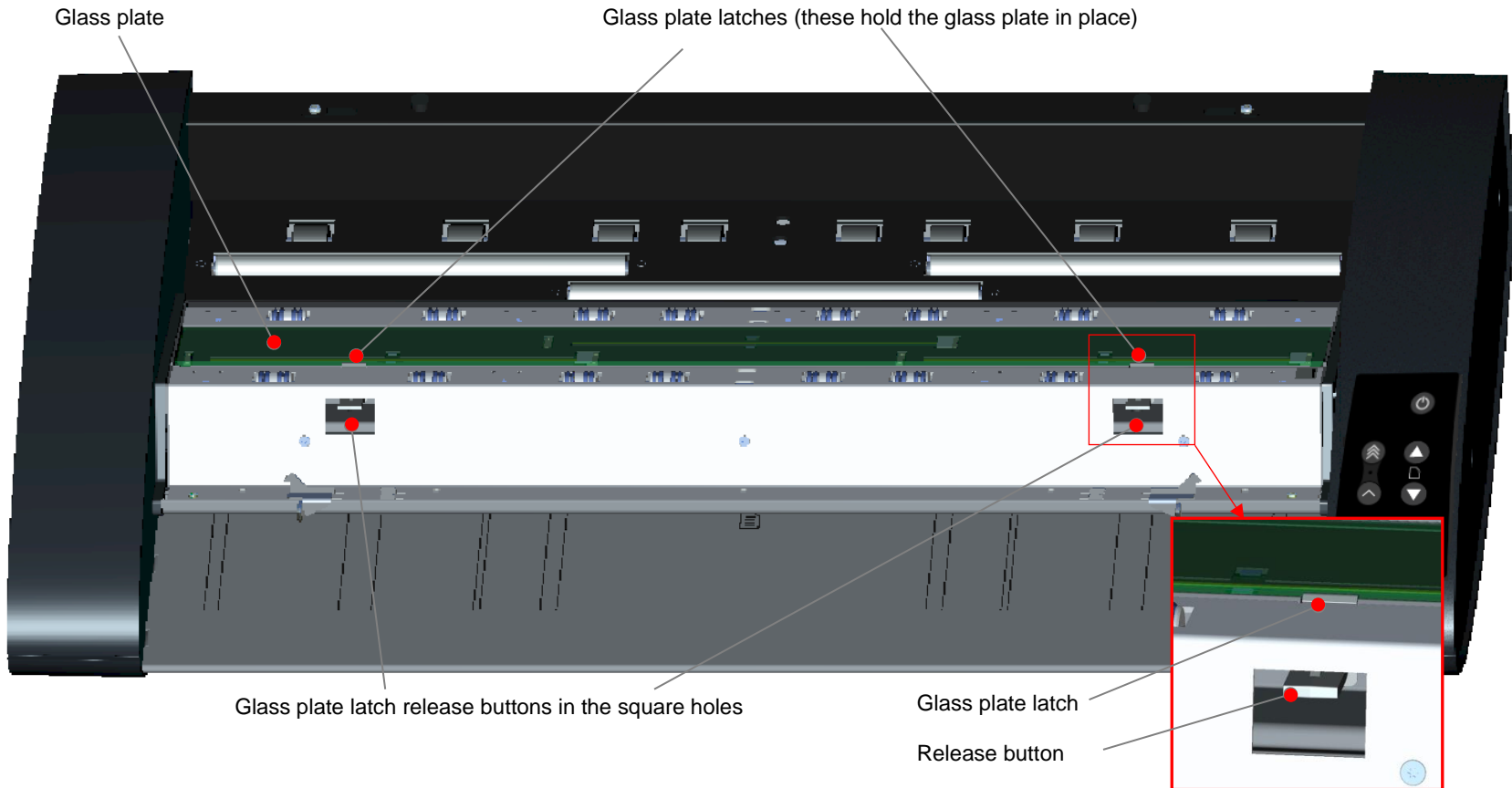

21

Detaching glass plate - right-side latch

Stand at the front of the scanner looking at the keypad end of the glass.

- Detaching the first (right) latch requires a sharp, flat tool like a pen or a small screwdriver



NOTE: A tool is only needed to start the removal process

- Locate the **arrow label** on the **RIGHT-SIDE** of the scanner
- With the tool just under the edge of the glass plate (see arrow) press down on the latch release button visible in the small square hole
- Using the tip of the tool pop the edge of the glass upwards until it's free of the white latch
- Let go of the latch release button

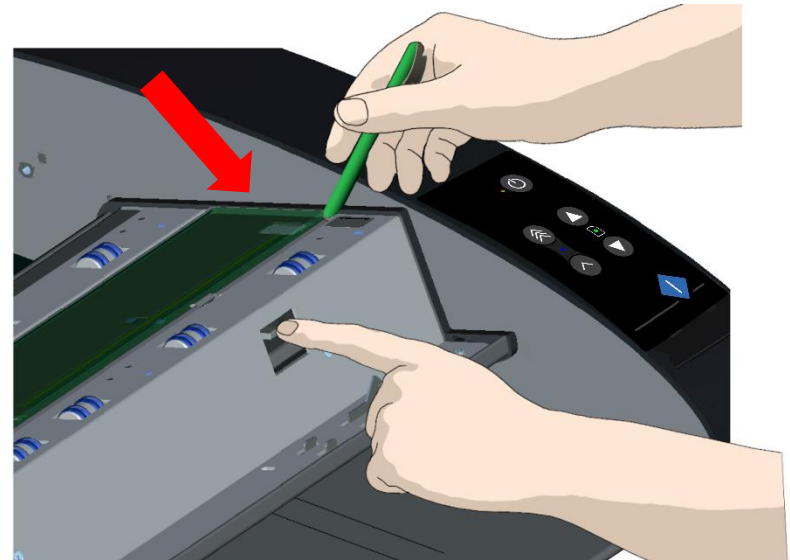

22

Detaching glass plate- remaining latches

After freeing the latch on the right-side of the lid, freeing the remaining latches becomes much easier.

- Working to the left press down the release button of the next latch
- The latch will release its grip and the glass will pop up over the latch
- Let go of the latch release button
- Repeat until all latches have been released

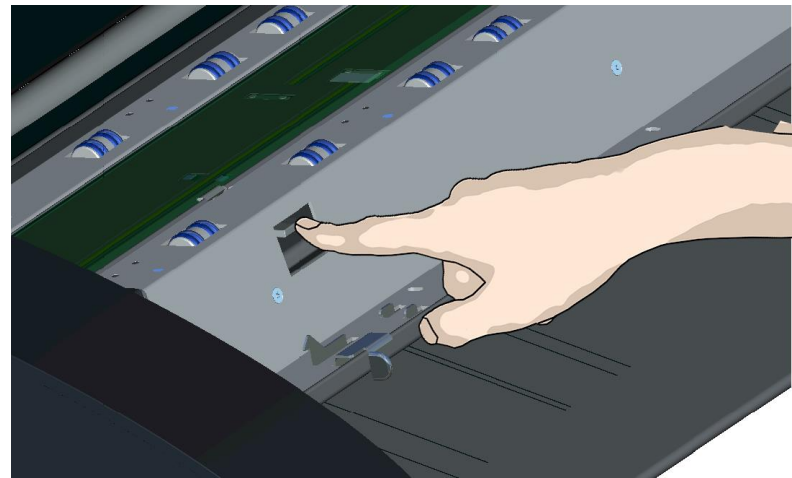

23

Preparing to remove the glass plate

- Stand at the front of the scanner
- Insert the tip of each thumb under the front edge of the glass in the middle area
- Tip the glass back and up so the two ends are free



NOTE: Use the flat tool again if you cannot get your thumbs underneath.

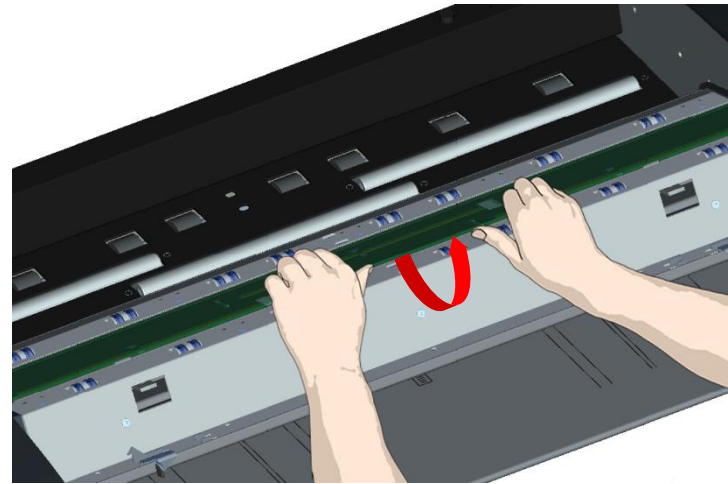

24

Lifting out the glass plate

- Move your hands one at a time to each end of the glass
- Apply light pressure with each hand as you lift the glass out of the scanner



CAUTION: The glass plate is fragile. Take care not to break it.

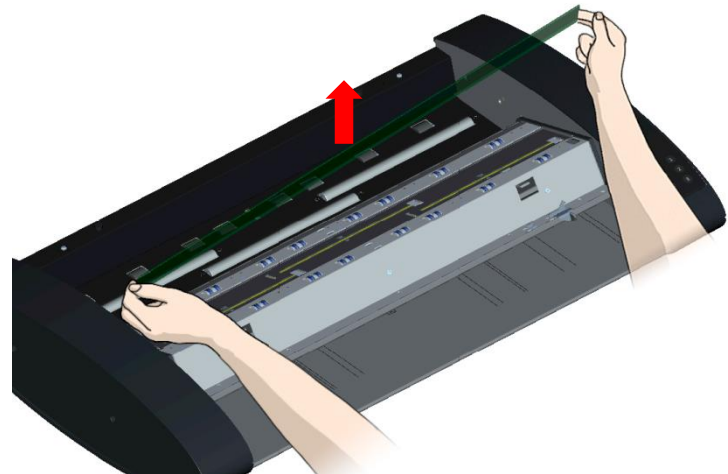

25

Installing a new scanner glass plate

- Pick up the glass plate from its ends to avoid touching the glass surface
- **Do not touch** the underside of the glass as this will not be cleaned during regular maintenance
- Stand at the front of the scanner
- Use the direction of the beveled edges of the glass to determine the underside
- Hold the glass so the underside faces down and at an angle towards your body as shown
- Maintaining the angle carefully lower the glass into the groove nearest the back of the upturned scanner lid (see next step)



CAUTION: The glass plate is fragile. Take care not to break it.

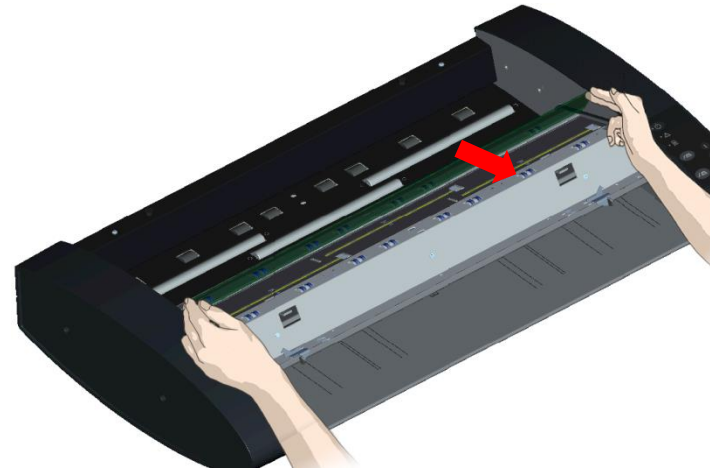

Glass Plate Profile:

As you lower the glass plate into the scanner, hold it at an angle similar to that shown in the illustration:

*Underside surface of glass plate
(This side faces your body as you insert the glass plate)*

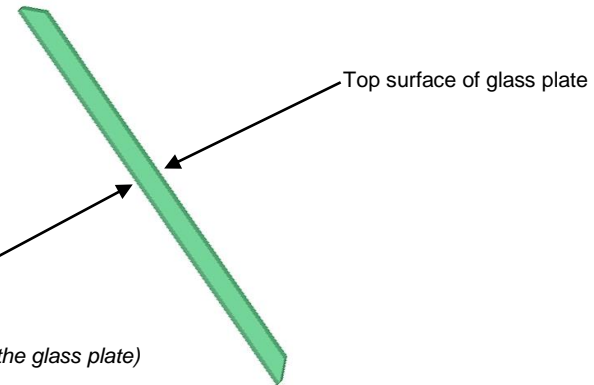

26

Glass plate location

- Identify the glass groove furthest from your body
- Place the lower edge of the glass plate in the rear position groove
- Carefully tilt the upper edge (the edge closest to your body) down until the glass plate rests in the two rear and front position grooves

Rear position groove

Glass plate lower edge

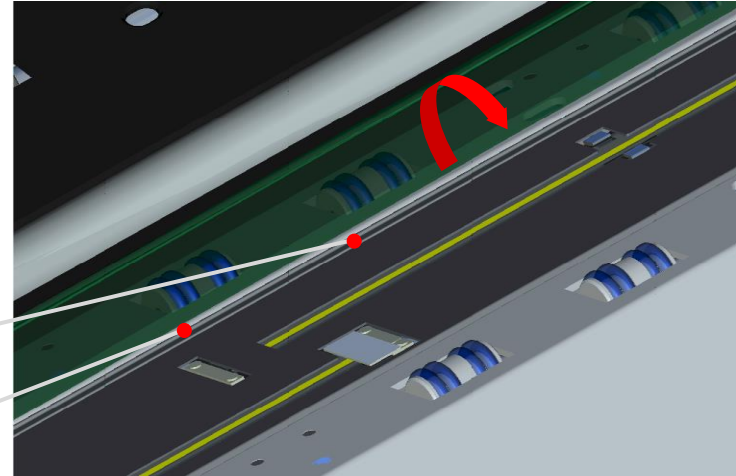

27

Lock the glass in place

- Hold down the latch release button nearest to the scanner keypad
- Press down on the glass near to the latch and click it into place
- Working to the left, move to the next latch and click that into place
- Repeat for any remaining catches
- Check all latches are properly gripping the edge of the glass before moving to the next step

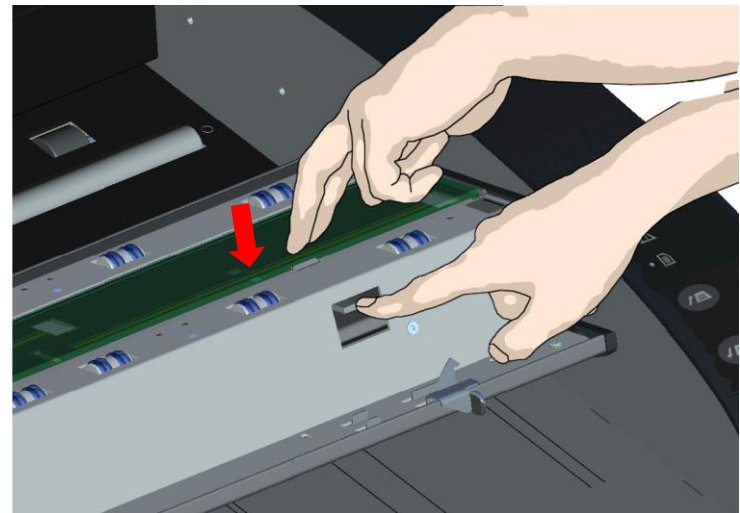

28

Clean the new glass plate

Obtain two fresh lint-free cloths.

- Spray or apply a mild, streak-free glass cleaner on a lint-free cloth
- Gently wipe the glass clean leaving no fingerprints
- Dry the glass completely using the other clean, dry lint-free cloth
- Make sure no fluid gets under the glass. Leave the area dry

 **CAUTION:** Do not spray/apply cleaner fluids directly on the glass plate or anywhere else in the scan area.

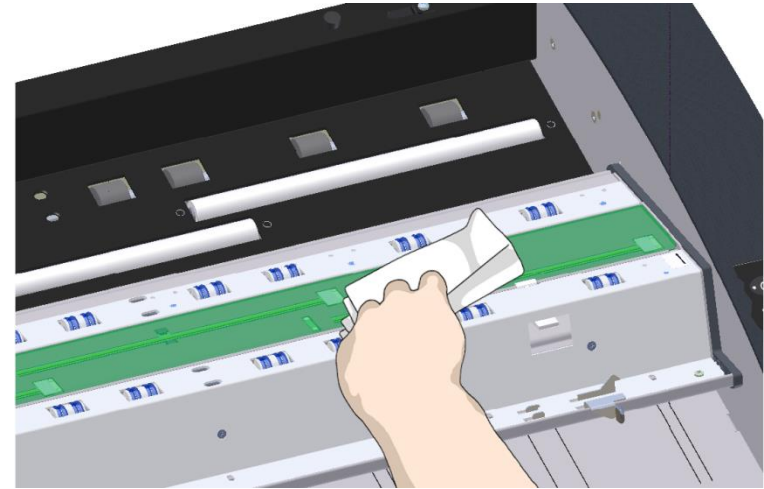

29

Close the scanner

- From the nearest edge lift the scanner lid and rotate it backwards and down you hear the lid latches “click”. Gently pull the lid to confirm it is locked
- Plug in the scanner and turn it ON

 **NOTE:** If images are not improved after changing the glass plate [calibrate the scanner](#) to adjust it to its new glass plate.



Downloading New Firmware

What is Firmware?

Like a computer uses an operating system your scanner uses firmware to run its systems and link with the software controlling the scanner.

When do I need new firmware?

Your scanner is shipped with the latest firmware available but from time to time the manufacturer may release a new version to make an improvement. Firmware upgrades can be downloaded from the manufacturer website or obtained from your dealer.

Upgrade your firmware when:

- One or more new features are released or other improvements are made to the scanner in firmware
- An error is discovered in the firmware version you have installed and the manufacturer recommends installation of a firmware upgrade



NOTE: Information about the upgrade will be included in the release firmware notes.

Identifying scanner firmware

- Start WIDEsystem and double-click its icon 
- Select the **Info** tab to view the following:
- *Firmware release* – the installed firmware version
- *Firmware download time* - when the firmware was installed

Firmware upgrade is possible if the installed *Firmware Release* number is lower than the newest firmware version number on the manufacturer website.

Installing new firmware

New firmware is installed by opening (running) the firmware.exe file saved to the scanner pc. Select the Save target (or Save Link) option from the web download page.

- From the manufacturer website save the firmware file to an empty folder on the scanner pc
- Double-click the file to start the firmware installation wizard and follow the screen instructions
- Installation takes about one minute during which the WIDEsystem icon will flash red



IMPORTANT: Do not switch off or interrupt the firmware upgrading process.

This section lists the most common issues that might affect your scanner and how you can overcome them. Please browse the problem descriptions and follow the procedure relevant to your situation before requesting a service call.

Scanner error reporting

The scanner panel error indicator LED will flash and WIDEsystem will display the error type on the pc screen.

Correcting scanner errors

- Follow the screen instructions if display, or
- Open WIDEsystem (double-click the WIDEsystem icon  on your system tray) and select the Status tab to view additional error information, or
- Look for a description of the error and remedy in the trouble shooting section of this guide

Technical assistance

You should contact your service provider if one or more of the following cases is true:

- the error cannot be remedied by following the action suggested on the PC screen
- the error and its remedy are not described in this user guide
- the system fails to report the error on your screen

Before calling technical assistance have the following ready:

- The scanner model number and serial number printed on the label on the back of the scanner. See the example IQ Quattro X 44 label below
- Write down your firmware version. See the section *Identifying scanner firmware*



NOTE: The website normally contains service provider contact information



<p>This Class A digital apparatus complies with Canadian ICES-003 Cet appareil numérique classe A conforme à la norme NMB-003 du Canada</p>	  		<p>MODEL NO: 型号 MU52D</p>	<p>SERIAL NO: 52DUYMnnnROC</p> 									
<p>This device complies with part 15 of the FCC Rules. Operation is subject to the following two conditions: (1) This device may not cause harmful interference, and (2) this device must accept any interference received, including interference that may cause undesired operation.</p>	  		<table border="1"> <tr> <td>FREQUENCY RANGE</td> <td>50 - 60 Hz</td> <td>頻率範圍 / 頻率範圍</td> </tr> <tr> <td>AC VOLTAGE</td> <td>100 - 240V~</td> <td>交流電壓 / 交流電壓</td> </tr> <tr> <td>CURRENT MAX.</td> <td>1A</td> <td>最大電流 / 最大電流</td> </tr> </table>	FREQUENCY RANGE	50 - 60 Hz	頻率範圍 / 頻率範圍	AC VOLTAGE	100 - 240V~	交流電壓 / 交流電壓	CURRENT MAX.	1A	最大電流 / 最大電流	 <p>Global Scanning Denmark A/S Svanewang 2, DK-3450 Alleroed, Denmark Designed in Denmark M2 Assembled in China 中国製造</p>
FREQUENCY RANGE	50 - 60 Hz	頻率範圍 / 頻率範圍											
AC VOLTAGE	100 - 240V~	交流電壓 / 交流電壓											
CURRENT MAX.	1A	最大電流 / 最大電流											
<p>声明 宽幅扫描仪 此为A级产品。在生活环境中，该产品可能会造成无线电干扰。 在这种情况下，可能需要用户对干扰采取切实可行的措施。</p>	<p>この装置は、クラスA情報技術装置です。この装置を家庭環境で使用すると電波妨害を引き起こすことがあります。この場合には使用者が適切な対策を講ずるよう要求されることがあります。VCCI-A</p>	 <p>US LISTED I.T.E. E482808</p>	<p>A014309 宽幅扫描仪 CONSUMO DE ENERGIA POR UNIDAD DE TIEMPO EN OPERACION DEL EQUIPO: 26Wh CONSUMO DE ENERGIA EN ESPERA POR UNIDAD DE TIEMPO DEL EQUIPO: 1Wh Laitte on liitettävä suojakasettimilla pistorasiin. Apparatet må tilkoples jordat stikkontakt. Apparatet skall anslutas till jordat uttag.</p>										

Scanner installation problems

Problem	Possible causes and remedy
<p>'Unknown device found' message</p>	<ul style="list-style-type: none"> • Your interface is not enabled on the PC or set up correctly. Check the installation steps for the selected interface. Check the interface and its driver are listed in the Windows device manager • WIDEsystem drivers were not installed before connecting the scanner. Shut down the scanner and PC, unplug power and USB 3.0 connections and restart the installation from step 1 as described in the installation section of this guide. If you continued installation before installing WIDEsystem, see the troubleshooting instructions below. • Loose interface connection at one or both ends. Unplug and then firmly reconnect the interface cable • System needs rebooting. Shut down the scanner and PC and unplug the power and USB connections. Then plug in the USB 3.0 connections and turn on the PC. When Windows is ready plug in the scanner power and turn on the scanner at the main power switch
<p>No functional drivers found – yellow error icon seen on scanner entry in Device Manager</p>	<p>If you connected and tried to install the scanner before installing WIDEsystem the “unknown device found message” will be displayed. If you ignored this and continued to step through the dialogs the scanner will have been installed as a new device without functional drivers. The scanner entry must be removed from the Device manager before re-installing correctly.</p> <ul style="list-style-type: none"> • In the Device Manager - remove the scanner entry • Shut-down the PC, shut down and unplug the scanner, disconnect the scanner from the PC • Run the installation from step 1 as described in the installation section of this guide. Be sure to install WIDEsystem before connecting the scanner

Scanner installation problems

Problem	Possible causes and remedy
WIDEsystem does not detect the scanner	<ul style="list-style-type: none"><li data-bbox="635 297 1822 368">• The WIDEsystem driver version installed on your PC is older than your scanner model. Install the WIDEsystem drivers from the WIDEsystem TOOLS USB drive that came with your scanner. If not available download the newest version from the manufacturer website or contact your dealer to obtain the correct WIDEsystem version.<li data-bbox="635 404 1822 454">• WIDEsystem drivers were not installed before connecting the scanner. Shut down the scanner and PC, unplug the connections and restart the installation from step 1 as described above<li data-bbox="635 489 1822 511">• Loose interface connection at one or both ends. Unplug and then firmly reconnect the interface cable<li data-bbox="635 546 1822 618">• System needs rebooting. Shut down the scanner and PC and unplug the power and USB connections. Then plug in the USB 3.0 connections and turn on the PC. When Windows is ready plug in the scanner power and turn on the scanner at the main power switch

Scanner operation problems

Problem	Possible causes and remedy
<p>Error - Indicator LED blinking</p> 	<p>An error was detected The error may be reported immediately through a screen message. If there is no message open WIDSystem (scanner icon on your system tray) and select the Status tab to view additional information about the error. Perform one of the following:</p> <ul style="list-style-type: none"> • Follow the instructions on screen and the actions required to remedy the error • Look for a description of the error in this user guide and follow the instructions provided <p>In some cases, you may need to contact your service provider for technical assistance if one or more of the following is true:</p> <ul style="list-style-type: none"> • The error cannot be remedied through the action suggested on your PC screen • The error and its remedy are not described in this user guide • The system fails to report the error on your screen
<p>Requesting technical assistance</p>	<p>In order to get the best and fastest solution to your problem, you should prepare as much information as possible before calling your service provider for technical assistance. Your manufacture's website contains service provider contact information.</p> <p>See instructions at the beginning of this section</p>

Scanner operation problems

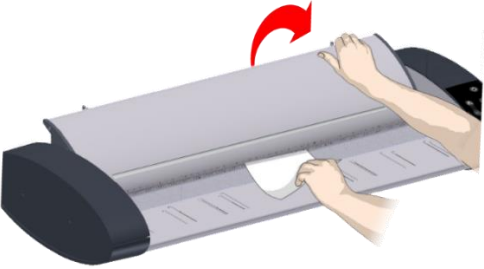
Problem	Possible causes and remedy
<p>Error message: Paper jam</p>	<p>Scanner stops scanning and the paper-ready LED goes out (stops blinking) when document still in drive system. Software displays 'Paper Jam Error'.</p> <ul style="list-style-type: none"> • Press and hold down the Paper-Backwards or the Paper-Forward key to eject the document from the scanner • If the document cannot be ejected using the keypad remove it after opening the scanner lid (see lid open instructions)  <ul style="list-style-type: none"> • Release and hold the lid open. Now gently remove the jammed document from the scanner  <ul style="list-style-type: none"> • Close the scanner lid • When the scanner is ready, reload the document again to resume scanning <p>If the paper jams again, repeat the steps above. Select soft-handling in the software before rescanning</p>

Scanner maintenance problems

Problem	Possible causes and remedy
<p>Error message: Stitching failed</p>	<p>Stitching maintenance error messages</p> <ul style="list-style-type: none"> • Dirty or smudged glass plate - Clean the scanning area, reboot the scanner and then complete the calibration steps as described in the section Maintenance • Loose object in the optical path - Remove any torn pieces of paper or other loose objects from the scanning area. Note that even very small loose objects can disrupt scanner calibration triggering an error <p>Call your technical service provider if the problem persists</p>
<p>Scanner will not connect or cannot be operated after a failed firmware upgrade</p>	<p>The scanner will boot into safe mode automatically allowing firmware re-installation when corrupted firmware is detected. A power failure may cause a firmware upgrade to fail.</p> <ul style="list-style-type: none"> • Restart the scanner • Confirm safe mode by confirming 'Scanner is in Safe Mode' message in WIDSystem • Follow the steps for installing firmware <p> NOTE: Safe Mode is for repairing a corrupted or interrupted firmware installation. Do not attempt to use the scanner in Safe Mode.</p>

Scanner result problems

Problem	Possible causes and remedy
<p>Scanned image is incomplete</p>	<ul style="list-style-type: none"> • Check the scanning software size settings are set to auto detection or the size of the original • Check the scanning software paper justification matches the position being used to load the original on the paper feed tray
<p>Image sections misaligned at sensor overlap (stitching)</p>	<ul style="list-style-type: none"> • Remove the original from the scanner and re-calibrate the scanner using the scanner maintenance program • If the problem persists after calibration the scanner sensors may need adjustment. Request assistance from your technical service provider
<p>Thin vertical lines showing in the paper direction of image not seen in the original</p>	<ul style="list-style-type: none"> • Clean the scanner glass and rollers as described in this guide • Wipe dirty documents with a dry lint-free cloth before feeding them into the scanner • If the problem remains re-calibrate the scanner using the scanner maintenance program. The scanner will 'memorize' dirt specs so you will need to re-calibrate the scanner after cleaning the scanner glass • If the problem persists after cleaning and calibration check the glass plate for scratches as a damaged glass plate should be replaced. Obtain a new glass plate from your service provider. Follow the steps in this guide to replace the glass plate

Important safety instructions



Read all of these instructions and save them for later use. Follow all warnings and instructions marked on the scanner.

- A.** Do not place the scanner on an unstable surface, stand, cart or table. Serious damage can be caused if the unit falls.
- B.** When cleaning, do not spray/apply liquid cleaners directly onto the scanner parts. Apply liquids to your cloth and then use the dampened cloth to clean.
- C.** Before **cleaning** or replacing any **user-replaceable parts**, be sure to turn the scanner power off and disconnect the power plug.
- D.** The scanner should be operated from the power source type indicated on the marking label. If you are unsure of the type of power available, consult your dealer or local power company.
- E.** The scanner is intended for use on IT, TT and TN power distribution systems and is equipped with a three-wire grounding type plug. This plug requires a grounded power outlet. This is a safety feature which relies on building installation. If you are unable to insert the plug into the outlet contact your electrician to replace the outlet. Do not defeat or ignore the purpose of the grounding-type plug.
- F.** Do not allow anything to rest on the power cord. Do not locate the scanner where persons will walk on the cord.
- G.** If an extension cord is used with the scanner, make sure that the total ampere ratings of the products plugged into the extension cord do not exceed the extension block ampere rating. Make sure that the total rating of all products plugged into the wall outlet does not exceed 15 amperes.

H. Slots or openings in the cabinet at the back or bottom are provided for ventilation. This ensures reliable operation of the product and protects it from overheating. These openings must not be blocked or covered. The openings should never be blocked by placing the unit on a bed, sofa, rug, or other similar soft surface. This product should never be placed near or over a radiator or heat emitter. This product should not be placed in a built-in installation unless proper ventilation is provided.

I. Never push objects of any kind into the scanner through cabinet slots since they may touch dangerous voltage points or short out parts that could result in a risk of fire or electric shock. Avoid any possibility of spilling liquid of any kind on the scanner.

J. Do not attempt to service the scanner yourself. Opening or removing the covers requiring tools may expose you to dangerous voltage points or other risks. Refer all servicing in these areas to authorized service personnel.

K. Unplug the scanner from the wall outlet and refer servicing to authorized service personnel under the following conditions:

- When the power cord or plug is damaged or frayed
- If liquid has been spilled into the scanner
- If the scanner has been exposed to rain or water
- If the scanner does not operate normally when operating instructions are followed then adjust only those controls covered by the instructions in this manual
- Improper adjustment of controls other than those mentioned in this manual may result in permanent damage and require extensive work by a qualified technician to restore the product to normal operation
- If the scanner has been dropped or the cabinet has been damaged
- If the scanner exhibits a distinct change in performance indicating a need for service

Regulations

FCC Regulations

USA

NOTE: This equipment has been tested and found to comply with the limits for a Class A digital device, pursuant to Part 15 of the FCC Rules. These limits are designed to provide reasonable protection against harmful interference when the equipment is operated in a commercial environment. This equipment generates, uses and can radiate radio frequency energy and if not installed and used in accordance with the instruction manual, may cause harmful interference to radio communications. Operation of this equipment in a residential area is likely to cause harmful interference in which case the user will be required to correct the interference at his/her own expense.

Caution: Pursuant to Part 15.21 of the FCC Rules, any changes or modifications not expressly approved by the manufacturer may cause harmful interference and void the user's authority to operate the equipment.

CE Regulations

EU

This equipment has been tested and found to comply with the limits for a Class A product according to EN55022.

VCCI Regulations

Japan

This equipment has been tested and found to comply with the limits for a Class A product according to Agreement of VCCI:2008 (CISPR 22).

この装置は、クラスA情報技術装置です。この装置を家庭環境で使用すると電波妨害を引き起こすことがあります。この場合には使用者が適切な対策を講ずるよう要求されることがあります。 VCCI-A

Toxic or Hazardous Substances or Elements

有毒有害物质或元素名称及含量

單元 Unit	Restricted substances and its chemical symbols 限用物質及其化學符號					
	鉛 Lead (Pb)	Mercury (Hg)	Cadmium (Cd)	六價鉻 Hexavalent Chromium (Cr ⁶⁺)	多溴聯苯 PolyBrominated Biphenyls (PBB)	多溴二苯醚 PolyBrominated Diphenyl Ethers (PBDE)
CIS module CIS 模組	X	○	○	○	○	○
備考 1. “超出 0.1 wt %” 及 “超出 0.01 wt %” 係指限用物質之百分比含量超出百分比含量基準值。 Note 1: “Exceeding 0.1 wt %” and “exceeding 0.01 wt %” indicate that the percentage content of the restricted substance exceeds the reference percentage value of presence condition. 備考 2. “○” 係指該項限用物質之百分比含量未超出百分比含量基準值。 Note 2: “○” indicates that the percentage content of the restricted substance does not exceed the percentage of reference value of presence. 備考 3. “-” 係指該項限用物質為排除項目。 Note 3: The “-” indicates that the restricted substance corresponds to the exemption.						

Scanner weights (unpacked) & dimensions

Scanner (Model)	L x W x H mm (inches)	Scanner Weight kg (lbs)
IQ Quattro X 3600 Series (MV52D)	1160 x 489 x 161 (45.7 x 19.3 x 6.3)	21.9 (48.3)
IQ Quattro X 4400 Series (MU52D)	1349 x 489 x 161 (53.1 x 19.3 x 6.3)	24.5 (54)

Low Adjustable Stand and High Adjustable Stand working heights

Scanner (Model)	Low Adjustable Stand mm (inches)			High Adjustable Stand mm (inches)								
	low	med	high	h1	h2	h3	h4	h5	h6	h7	h8	h9
IQ Quattro X 3600 Series (MV52D)	827 (32.6)	859 (33.8)	884 (34.8)	1092 (43)	1117 (44)	1142 (45)	1167 (45.9)	1192 (46.9)	1217 (47.9)	1242 (48.9)	1267 (49.9)	1292 (50.9)
IQ Quattro X 4400 Series (MU52D)												



NOTE: The high and low adjustable stand accessories are not standard equipment with IQ Quattro X scanners and need to be ordered separately.

Low Adjustable Stand

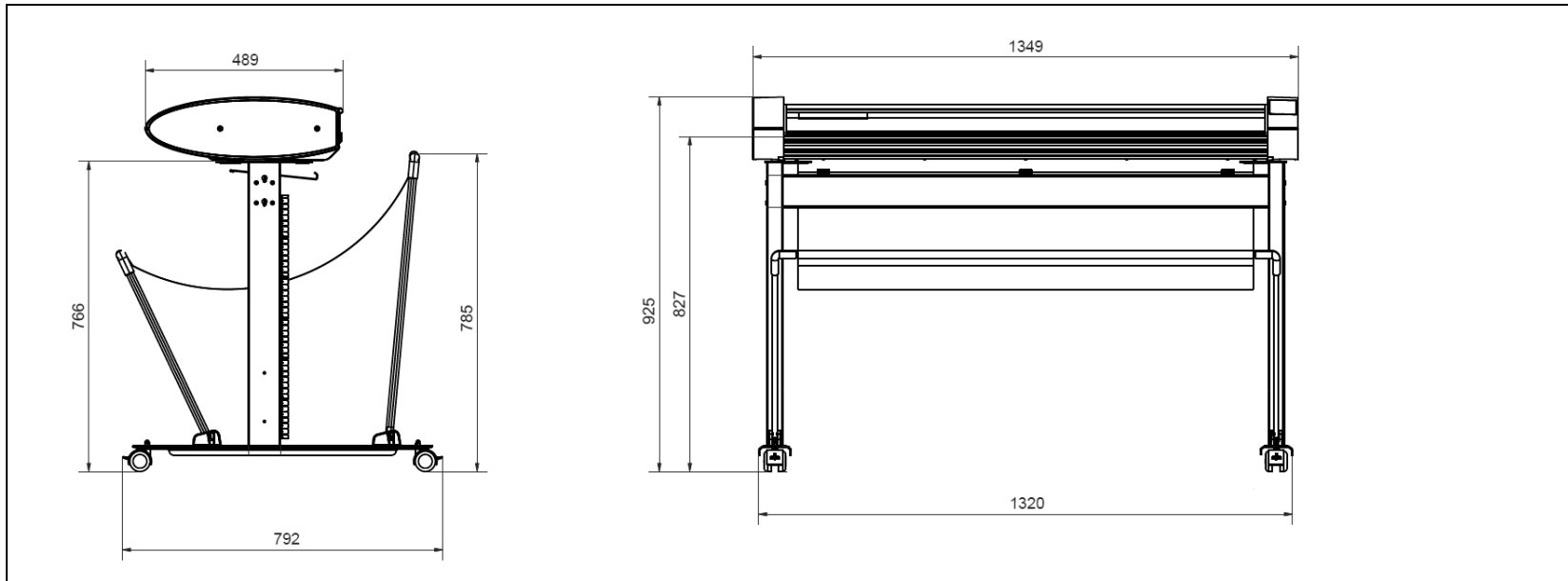

NOTE: Drawing shows stand (44") at its lowest working height setting of 827 (dimensions in mm).

High Adjustable Stand

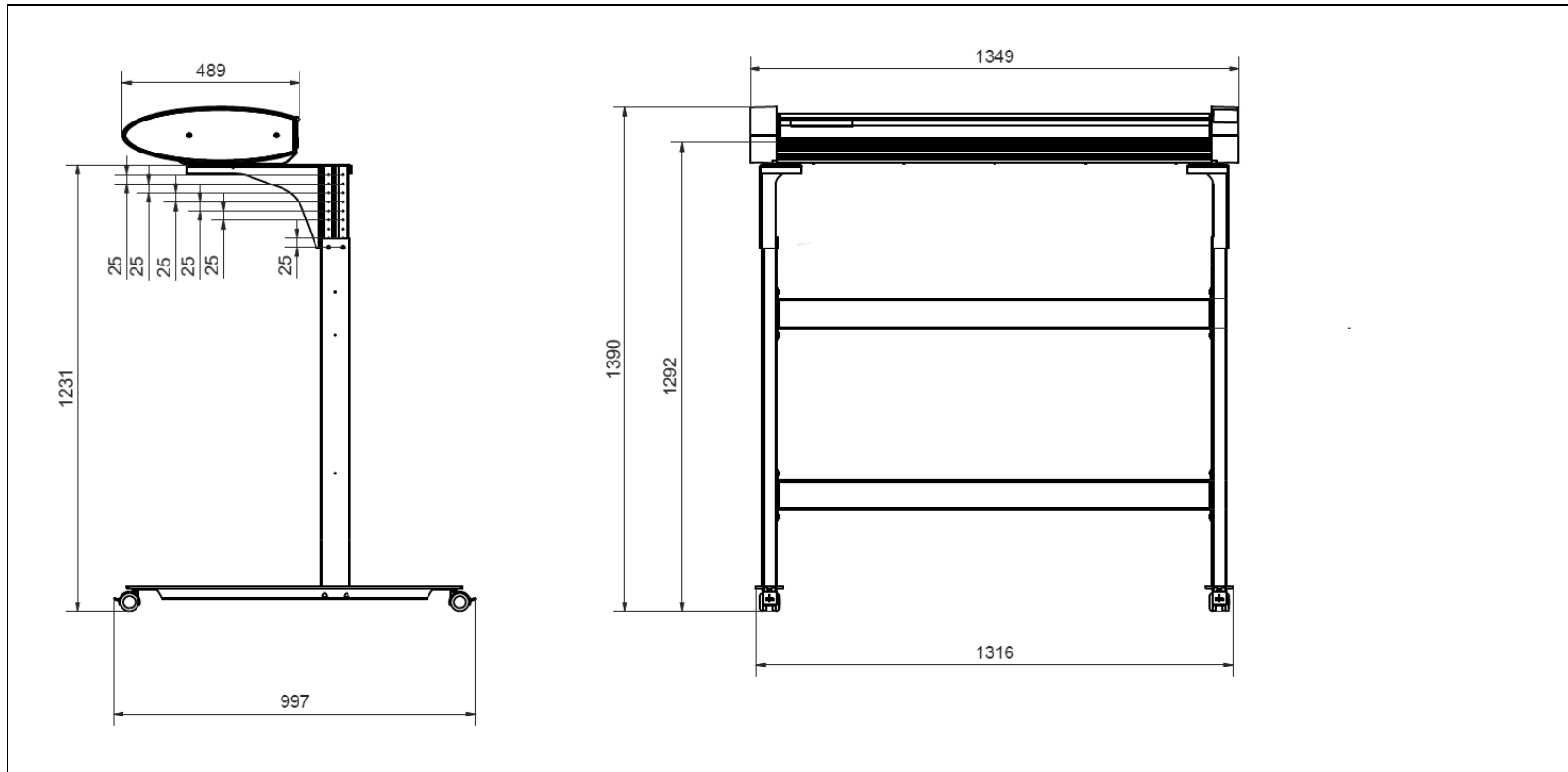

 **NOTE:** Drawing shows stand (44") at its highest working height setting of 1292 (dimensions in mm).

Contex HQ & EMEA

Global Scanning Denmark A/S
Copenhagen, Denmark
Phone: +45 4814 1122
info@contex.com

Contex Americas

Global Scanning Americas (MD) Inc.
Chantilly, VA. 20151, USA
Phone: +1 (703) 964 9850
salesamericas@contex.com

Contex Japan & Asia

Global Scanning Japan A/S
Yokohama, Japan
Phone: +81 45 548 8547
apac@contex.com

