

User Guide

Wide Format Flatbed Scanner



Model: IQ FLEX

UG13523-2 EN IQFLEX OCT 2019

Table of Contents

About this Guide	3
Main Specification	4
Installation	5
Scanner requirements.....	5
Assistance and Safety.....	5
Unpacking	6
Packaging observations.....	6
Placing the scanner on a suitable surface.....	7
Lifting the scanner.....	8
Cleaning	9
Checking the glass area.....	9
Cleaning the glass area	10
Preparing the scanner for first use	11
Connecting power	11
Touch screen preparation	13
Connecting to a local area network (LAN).....	14
Turning on the power	15
Startup Wizard	16
IQ FLEX touch screen interface	17
Running the Wizard.....	18
Configuring for a local area network (LAN)	18
LAN settings.....	19
Scanner network name	19
Language	20
Setting Date and Time	21
Configuring the scan to email settings	22
Setting up the printer.....	23
Activating the scanner (online method).....	25
Activating your scanner (offline method).....	26
User Interface	28
IQ FLEX functions.....	28
Turning the scanner ON and OFF	29
Main power switch	29
Sleep mode.....	29
Scanning	30
Basic steps.....	30
Scan preparation.....	31
Normal scan mode.....	32
Oversize scan mode	33
Book scan mode	34
Adjusting the lid for thick originals.....	35
Positioning originals	36
Paper sizes and guides.....	37
Scanning oversize documents	40
Positioning oversize documents.....	41
Book positioning.....	42
Book scanning without software.....	43
Book scanning using Nextimage.....	44
Further notes about input size.....	45
Using the USB socket.....	46
Scanning to email	47
Scanning thick media.....	48
Scanning to personal PC and Cloud destinations.....	49

Scan to file settings	50	Scanner maintenance tasks	65
Color Validation (draw line)	51	Cleaning the scan area	66
Color Validation (add text)	52	Cleaning the glass	67
Color Validation (change brightness)	53	Replacing the white background platen	68
Gray Validation (change brightness)	54	Preparing to calibrate the scanner	69
Black and White Validation (darken lines)	55	Calibrating the scanner	70
Contex LINK scan client	56	Updating your scanner software	72
Scanning to the cloud	57	Updating the Contex LINK client software	73
Copying	58	Troubleshooting your scanner	74
The basic steps of copying	58	Technical Service	74
Copy settings	59	Problems with the scanner installation	76
Wi-Fi – Connecting to a wireless network	61	Problems operating the scanner	77
Settings and preferences	62	Problems with the scan result	78
WIDEsystem	63	IMPORTANT SAFETY INSTRUCTIONS	80
Nextimage	63	REGULATIONS	81
Administrator console	64	FCC Regulations	81

About this Guide

This user guide applies to the following model(s):

Scanner Model	Description
IQ FLEX	18" / A2 flatbed color scanner



ENERGY STAR[®] compliant

This guide explains how to operate and maintain your wide format flatbed scanner.

The guide assumes basic knowledge of your computer and operating system and does not repeat information that would be covered in their own user documentation.

Be sure to refer to:

1. The Installation section that describes how to correctly install and activate your scanner.
2. The Safety Instructions.
3. The Scanner Maintenance section that describes how to get the best results from your scanner.

Main Specification

The IQ FLEX is an A2 flatbed scanner with integrated touch screen controller designed to capture images from flat documents which are either too fragile, irregularly shaped or too thick to be scanned by other scanners. The scanner will allow oversize scans up to A1 to be made. Connecting to Ethernet networks allows convenient scan to cloud operation while the onboard USB socket permits the operator to save any scan direct to portable memory.

Connectivity	Gb Ethernet
Scan to USB	USB3 on scanner
Color Speed (200dpi)	Full scan bed in 6 seconds
Mono Speed (200 dpi)	Full scan bed in 6 seconds
Scan size	A2 / C-size
Over size scanning	A1 / D size Scan width Arc C +30mm = 18"+30mm = 487,2mm Scan length Arc C +30mm = 24"+30mm = 639,6mm
Optical Resolution	1200x1200 dpi
Max Resolution	9600 dpi
Accuracy	0.1% +/- 1 pixel
CIS	Canon CIS
Power Consumption : (Ready / Sleep Mode / Scanning)	Max 10W / 0.5W / 23W
Unpacked Weight / Dimensions (W x L x H*)	35kg (77lbs) / 661mm (26") x 1176mm (46") x 194mm (8")
Packed Weight / Dimensions (W x L x H)	43kg (95lbs) / 840mm (33") x 1310mm (52") x 290mm (11.3")
Packaging method	Foam shock protection frame inside thick cardboard box
Operating Maximum Ambient Temperature	This product has been submitted and evaluated for use at the maximum ambient temperature (Tma) permitted by the manufacturer's specification of 40°C.

*Touch panel in raised position

Scanner Setup

Installation

Scanner requirements

- Firm, flat surface or table at least 75cm x 135cm with an area at least 80cm of free space above the surface.
- Grounded power outlet.
- Network connected pc to run Contex Link software (supplied).
- Gigabit Ethernet wall socket.
- Internet support for connection to cloud services.

Assistance and Safety

- Ensure you have adequate help to unpack and position the scanner
- Make sure that you do not trip over any packing material while carrying the scanner

Unpacking

1

Packaging

Packaging observations

- Be sure to retain the packing material if you intend to move the scanner to another site.
- Do not leave empty packaging blocking a right of way or fire exit
- Always dispose of the packing material responsibly if you no longer require it.
- Make sure you remove the accessories kit and any documentation from the packing before discarding.

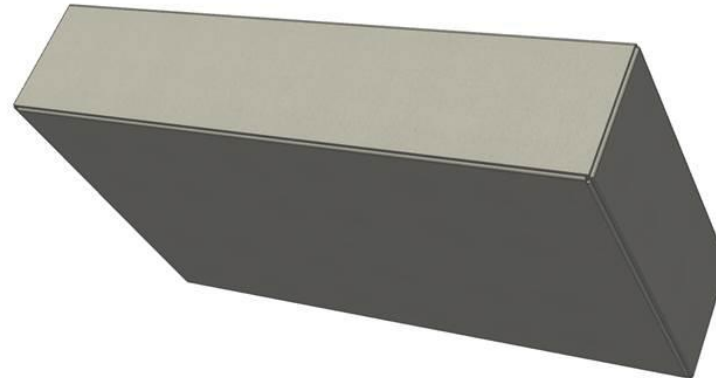
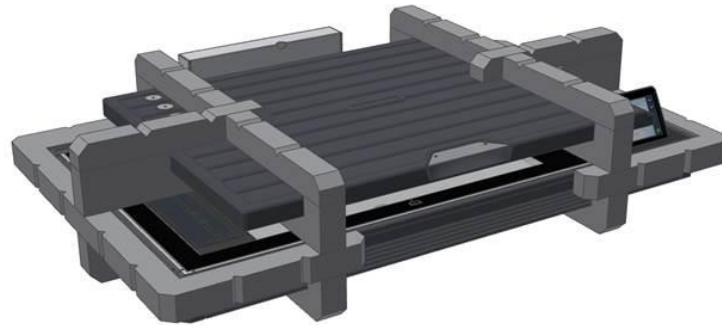

Placing the scanner on a suitable surface

2 Important

Your wide format flatbed scanner should be placed on a single, stable, level and completely flat (plane) surface like a well-made table. If convenient, you can place the back end of the scanner against a wall leaving space for the cables to be connected at the back. Make sure there is room above the scanner to raise the lid completely into the upright position. It is a good idea to have at least 900mm available so that the lid can be removed for maintenance if necessary.

The surface underneath the scanner should not impart tension on the scanner's frame caused by unevenness. **THIS IS VERY IMPORTANT.** Failure to ensure the surface is flat may produce poor scanning results and could cause damage to the scanner device over time.

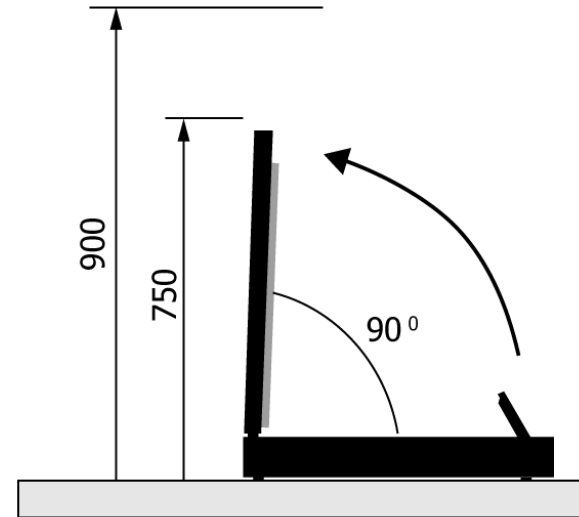

Lifting the scanner

3

Taking care

The scanner rests on four rubber feet positioned on the underside of the scanner.

1. CAUTION. The scanner is heavy (35kg/77lbs). Never attempt to lift the scanner on your own. Always seek the help of a second person when lifting the scanner from its packaging material or when you want to move the unit.
2. Find a sturdy table or surface on which to use the scanner.
3. The sides of the table or surface must be easily accessible by those installing the scanner so as to avoid possible back injury when lowering and maneuvering the scanner into position.
4. The small height of the scanner feet means that the case of the scanner rests close to the surface it used on. This is a potential finger trap when lowering the scanner into position.

 **TAKE CARE NOT TO TRAP YOUR FINGERS WHEN PLACING THE SCANNER!**

 **SEE THE SAFETY INSTRUCTIONS AT THE END OF THIS OPERATOR GUIDE**

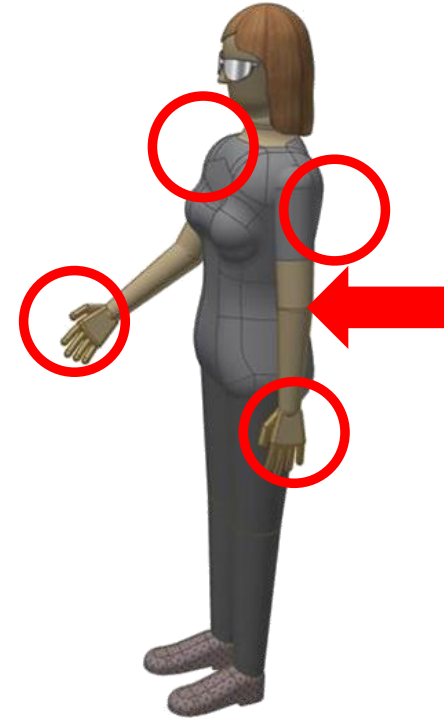

Cleaning

Checking the glass area

4

Open the scanner lid

The internal scan area (glass plate) should be wiped clean of any dust that may have accumulated from the packaging or during the shipping process.

Lift up the scanner lid to expose the glass scan area.



Cleaning the glass area

5

Clean the internal scan area

Lightly wipe the internal scan area's glass plate free of dust. Use a dry lint-free cloth.

If you detect difficult smudges on the glass that cannot be wiped clean with a dry cloth, refer to this guide's section *Cleaning the scan area* for instructions on thoroughly cleaning the scan area.

Close the lid after cleaning the internal scan area.



Preparing the scanner for first use

Connecting power

6

Connect the power cable to the scanner

Locate the power supply which is already wired with a special plug ready to be inserted into the round socket in the panel on the back of the scanner. Take care to insert with the flat side of the plug facing upwards. Do not force the plug into the socket.

Now locate the separate supplied mains power cable.



7 Connecting the power supply to the power outlet

Connect the female end of the mains cable into the power supply then connect the power plug end to a suitable power outlet.

CAUTION: The scanner is equipped with a three-wire (pin) grounding type plug. If you cannot insert the plug into your outlet it means your outlet is not earthed. Contact your electrician to replace the outlet with a grounded power connection or use a different earthed outlet. Do not try to defeat or ignore the purpose of the grounding-type plug.

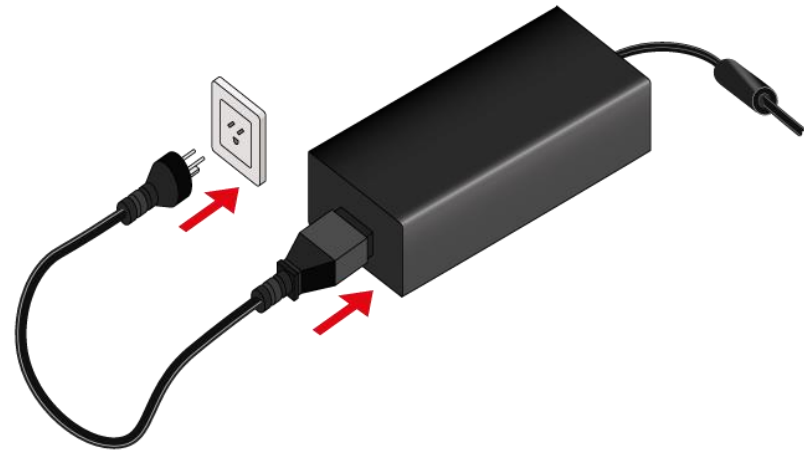

Touch screen preparation

8

Lift up the touch screen

Grasp the top edge of the screen and fold it up and into the upright position.



NOTE: Avoid using extreme force when raising or lowering the screen.



Connecting to a local area network (LAN)

9 Connect to the network

Connect the scanner to the network. The network socket is on the panel located at the back of the scanner.

The USB ports outlined in red are for maintenance and future upgrade purposes only. These should not be used. Do not insert any cables or USB memory drives into these sockets.



Turning on the power

10

Turn ON scanner power

Turn ON the scanner power switch on the back of the scanner by moving the switch the left.



Startup Wizard

11

Turning the scanner ON for the first time

Turn on the main power switch on the panel at the back of the scanner.



NOTE: When the scanner is switched on for the first time the IQ FLEX *Wizard* will take the user through a series of configuration pages on the touch screen.

The Wizard sets up:

Network Connection (for communication to printer(s), cloud and network computers)

Languages (keyboard and screen can be different)

Date and Time

Email Server settings (for sending scans to recipients via email)

Activation of the scanner

Any of these settings can be skipped and returned to at a later time by touching the Settings icon on the front screen.

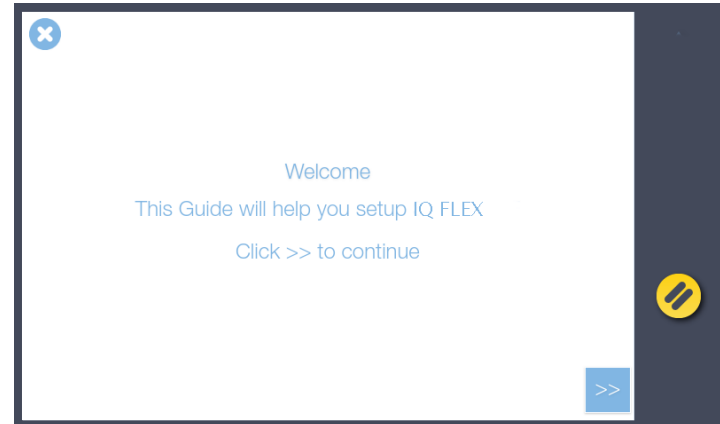

Scanner Setup

IQ FLEX touch screen interface

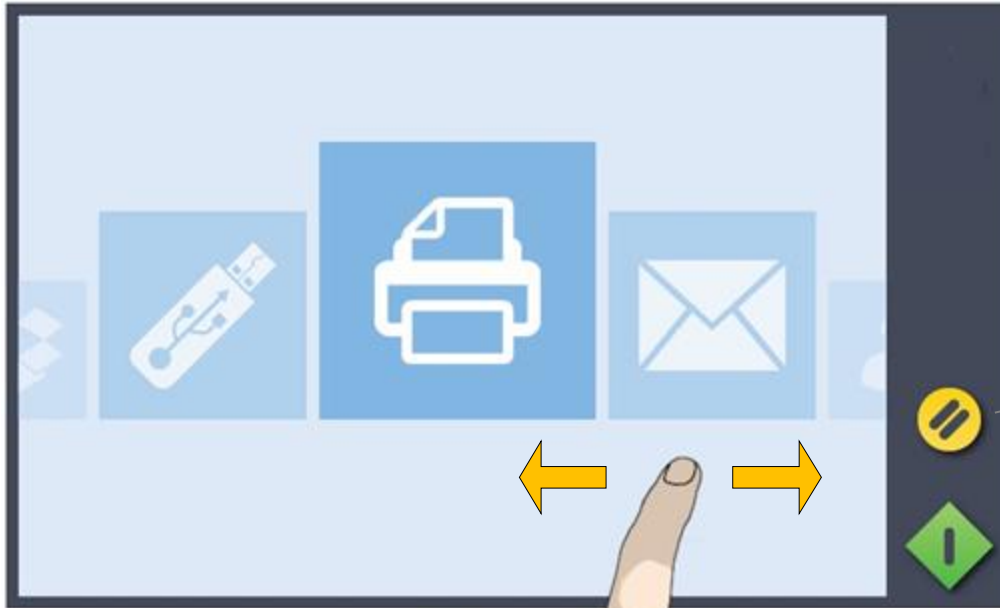

Reset
To reset from any state and go back to start

Go button
To start a scan or copy after making any settings changes (if required)

Scroll menu
Scroll on the touch screen in both directions to view and select

Running the Wizard

12

The Installation Wizard starts

The IQ FLEX welcome screen signals that the scanner installation process has begun.

The following screens contain the various installation steps required to set up the scanner. Follow the screens shown in [path] below to return to this area after the wizard has completed.

Press the Next button >> to proceed.

Use the Back << button to go back a step (where displayed).

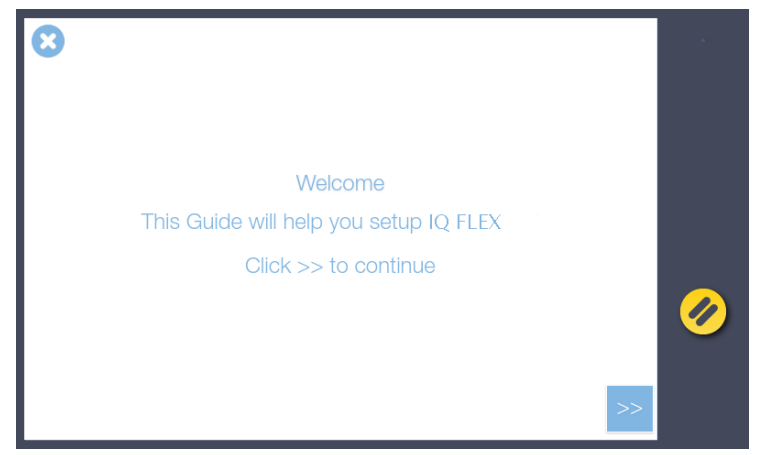

Configuring for a local area network (LAN)

13

LAN network settings (DHCP)

By default the scanner will automatically try to obtain an IP address using DHCP if cable connected to a local area network (LAN).



[Settings > System > Network]

Press the Next button >>

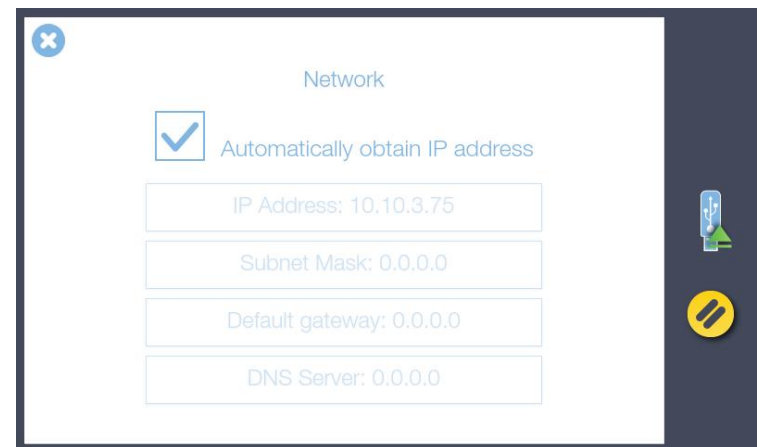

LAN settings

14 LAN network settings (STATIC)

To manually set a static network IP address follow the screens shown in [path] below to uncheck 'Automatically obtain IP address'. A static address and subnet mask can now be set. Consult your IT person if necessary.



[Settings > System > Network]

Press the Next button >>

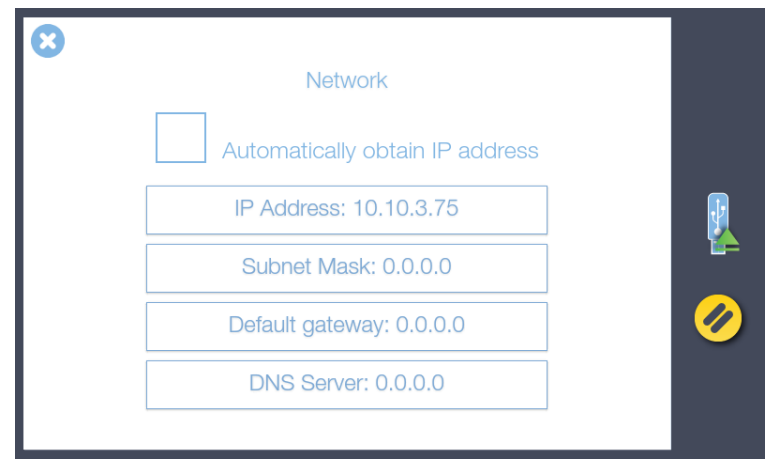

Scanner network name

15 Using Wi-Fi

If a Wi-Fi network is in range and the physical LAN is disconnected, the scanner will automatically display a highlighted 'Select WiFi Network' button. Touch the highlighted button to connect using wifi. See Using the WiFi Connection later in this manual for more information.



[Settings > System > Network]



Language

16

Select your language

Select the preferred language for the screen and keyboard. Different languages can be combined as the screen and keyboard languages do not have to be the same. Selecting a new language updates the current setting.



[Settings > System > Language]

Press the Next button >>

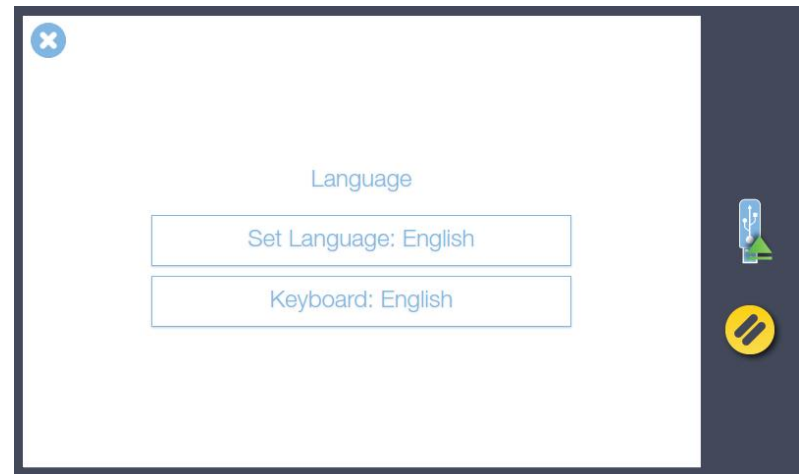

Setting Date and Time

17

Set your region date and time

1. Set the date.

Touch the Date area onscreen to bring up the numerical touch keypad then enter today's date in dd.MM.yyyy (day.short-month.year) format. Press Enter to store the value.



[Settings > System > Regional]

2. Set the time.

Touch the Time area onscreen then using the numerical touch keypad enter the time in 24-hour format. Press Enter to store the value.



[Settings > System > Regional]

Press the Next button >>

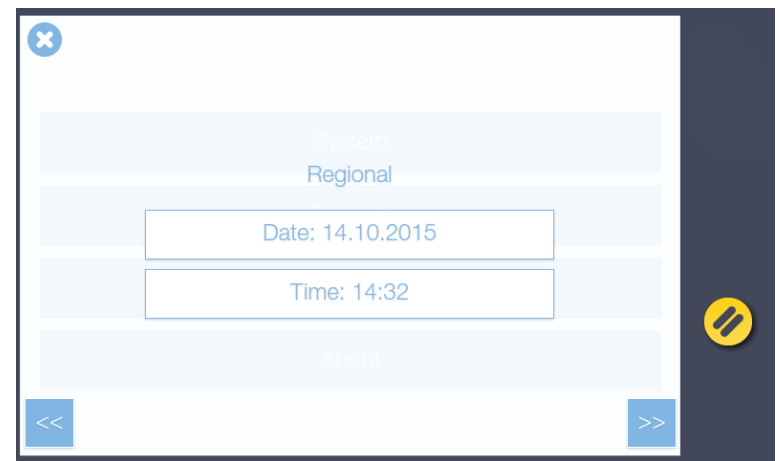

Configuring the scan to email settings

18

Entering the email server settings

Enter your email server details to have scans sent directly via email:

1. Host (server name), Port (port number) and Connection (security type)
2. Account and Password - for the target email account
3. Name – email account name of the person to receive the scans
4. Max MB - the maximum size of email the server should allow (including the attachment)
5. Test - checks the email account settings entered above
6. Address Book - if set to yes all email addresses sent to will be collected in an address book for easy re-selection



[Settings > System > Email]

Contact your IT administrator if you don't know the exact settings.

You can skip this step during installation and complete it later if you want to.

Press the Next button >>

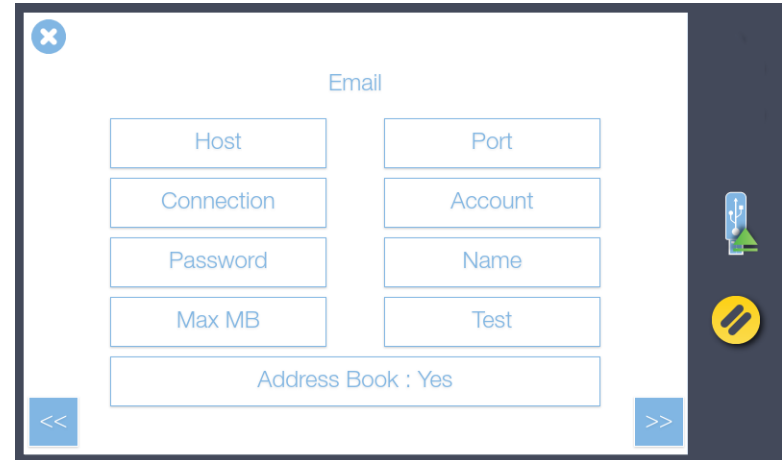

Setting up the printer

19a

Setting up the printer

1. Press *Setup* to select and set up your printer for making copies.
2. Enter the printer IP address (preceding zeros can be ignored, for example 050 can be entered as 50) and allow the scanner to locate it. Contact your IT administrator if you don't know the IP address settings for your printer.
3. Enable *Compensate for the printer margin* to have the scanner allow for the outer paper edges that cannot be reached or printed on by the printer. This ensures the unused margins in the printed original are not reproduced in the copy.
4. Press the *Media Profiles* button to start the media profile wizard.

You will need to create media profiles for every type of media that will be used with the printer. Media profiles ensure optimal color copy results.

Press the Next button >>



[Settings > System > Printer]



NOTE: For Epson printers please select the media type loaded in the printer through the printer's control panel then choose the same media type from the choice of medias displayed in the scanner media list. For optimal copying performance the profile media-type chosen at the scanner should match the media-type loaded in the printer.

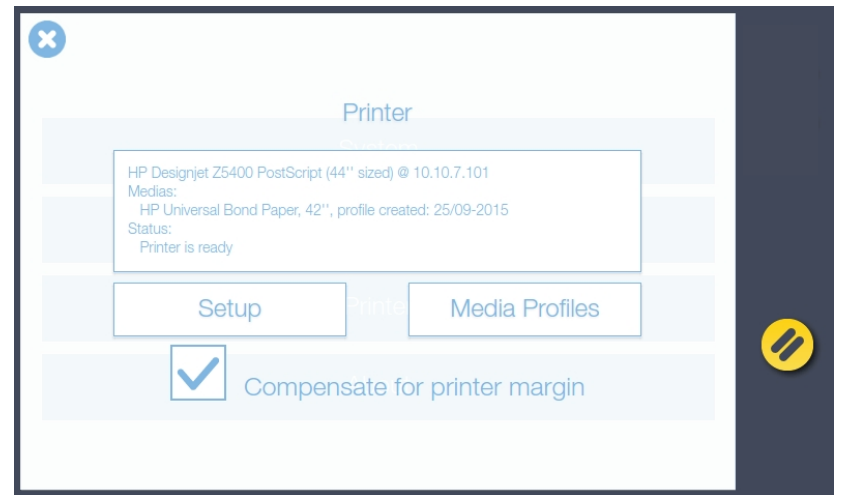
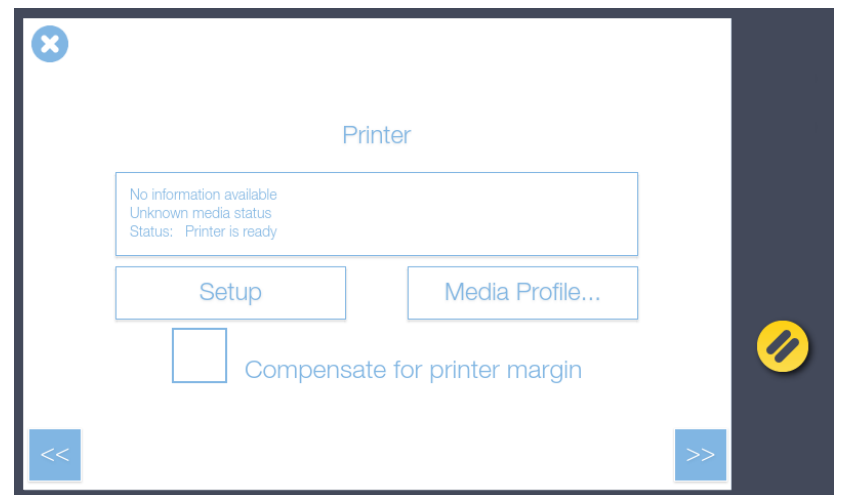

19b

Create printer media profiles

5. On the Printer screen (previous page) press *Media Profiles* then select the current media type loaded in the printer (Plain Paper in this example).
6. Now press the *Print* button to print the color calibration page. It is important that the printer is working properly for this operation.
7. Load the printed color calibration page into the scanner taking care to align the black arrow with the scanner center load point. Now press the *Scan* button to scan the printed color calibration page.



8. Press OK when you see the *Media Profile Created* message.
Make a new profile for each different type of paper used in the printer you wish to copy to.



NOTE: If the scanner reports that it cannot find the calibration page reload it and press the Scan button again to repeat the process.

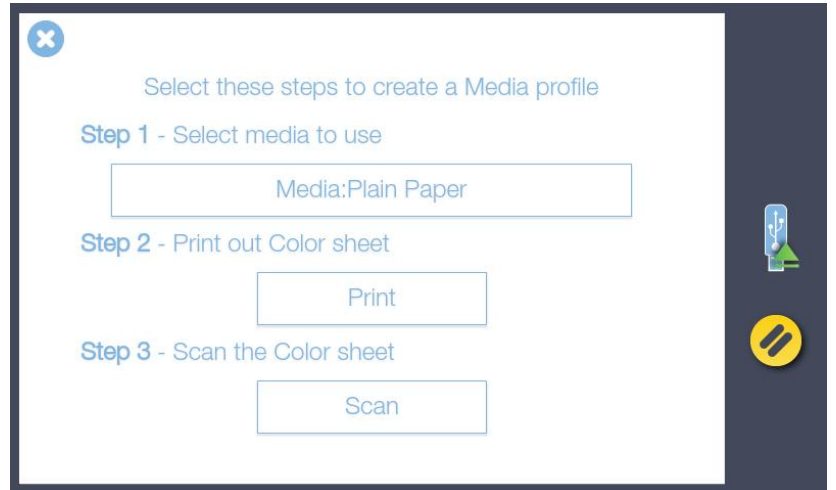
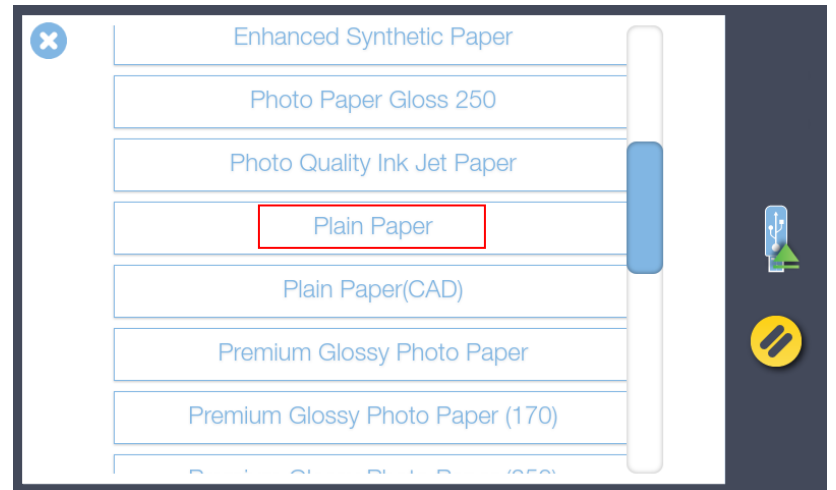

Activating the scanner (online method)

20

Activating an online scanner

You must activate your scanner with its license key before it can be used. The easiest way to do this is by connecting the scanner to the internet through its network connection.

1. Make sure your scanner is connected to the network which can get to the internet.
2. Locate your customer scanner activation sheet. The license key is encoded in the QR code and will be read by the scanner then verified over the internet.
3. Load the sheet in the scanner and press the scan button  to activate the scanner
4. If the activation sheet fails to activate the scanner use the offline option instead and manually type in the license key.



THE SCANNER SYSTEM IS NOW ACTIVATED

Activating your scanner (offline method)

21

Activating an offline scanner

You can still activate your scanner manually if it is not directly connected to the internet via your network. You will need a separate device or computer with an internet connection.

1. Have your *License Key* ready before proceeding. If you don't have one, contact your dealer.
2. Manual activation uses an online web interface to generate the Activation Code using the License Key from your dealer and the Hardware ID from the scanner.
3. Using the browser of your internet device follow the instructions below:

(On your internet device)

go to www.licenseactivate.com

#1 Enter the *Serial Number* or *Hardware ID* key for the scanner.

#2 Enter the License Key

#3 Press the Activate button to generate the Activation Code and write it down

(At the scanner)

#4 Enter the Activation Code into the white area at the bottom of the blue Manual Activation screen where the wording 'Enter activation code' is displayed.

THE SCANNER SYSTEM WILL NOW ACTIVATE

Manual Scanner Activation

To get an activation code, you need to register a license key on the internet. Please follow the steps below:

1. If you do not have a license key contact your dealer to obtain one.
2. From an internet-connected device, visit www.license.context.com
3. Enter your license key and the following Hardware ID:
4. Hold the resulting activating code and enter it below

987654321

Enter activation code

License Activation

Please complete the form below

Activation Information

(*) marks required fields

Serial Number or Hardware ID:

License Key:

Contact Information

Company Name:

First Name:

Last Name:

Email:

City:

Postal Code:

Country:

State:

I would like to receive product news and technical information

Click here to help us learn more about your needs

[Privacy Policy Statement](#)

Activate #3

Support
[Need to deactivate your scanner?](#)
[Replaced board in your scanner?](#)

License Activation

✓ Activation Code Generated

Activation Code Information

Serial Number	AA0B-4AWB-CSAB-WAAY-SABF-EANA	#4
Activation Code	AC5MBP-3ZM6NF-V9P2K5-DRP3UB-2F333L-ERLFKQ	

22

Installation and Activation completed

When the scanner has been correctly installed the screen will briefly show the "Scanner is activated" message and then switch to the normal start screen where the full range of scanner options will be displayed.

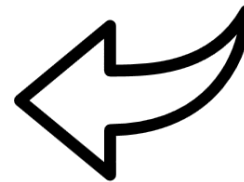
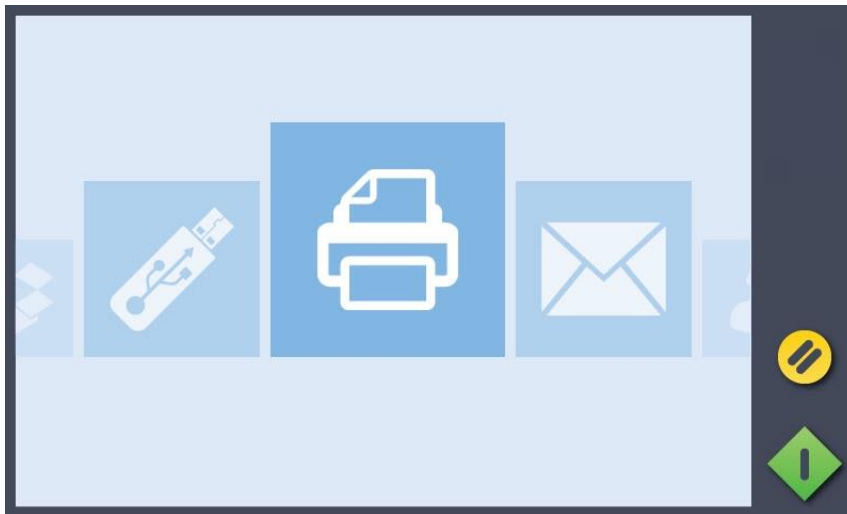
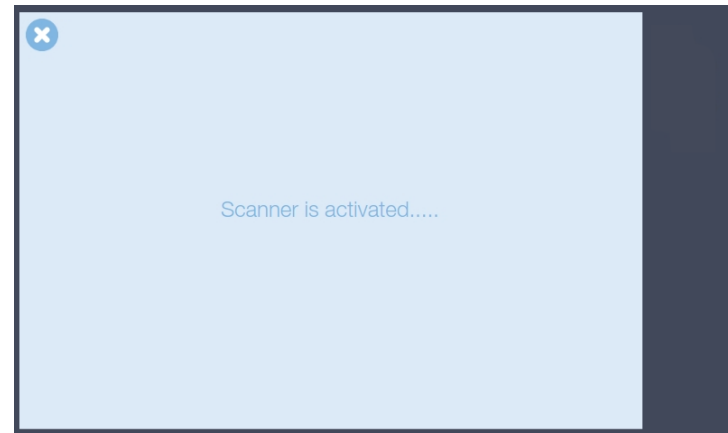

User Interface

IQ FLEX functions

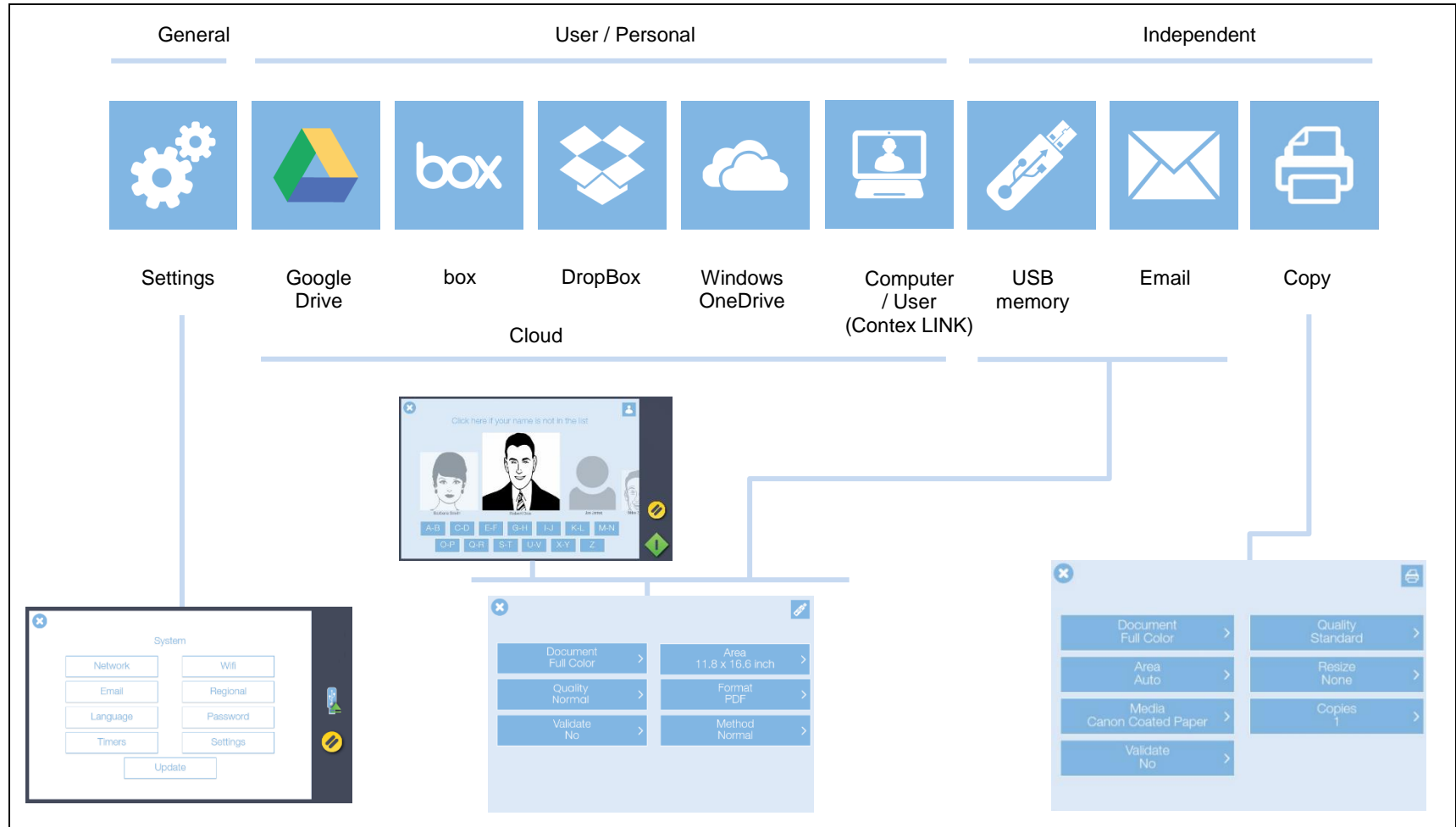

Turning the scanner ON and OFF

Main power switch

The main power switch is at the back of the scanner.

- Press the left side of the switch (marked “I”) to turn the main power to ON.
- Press the right side of the switch (marked “O”) to turn the main power to OFF.

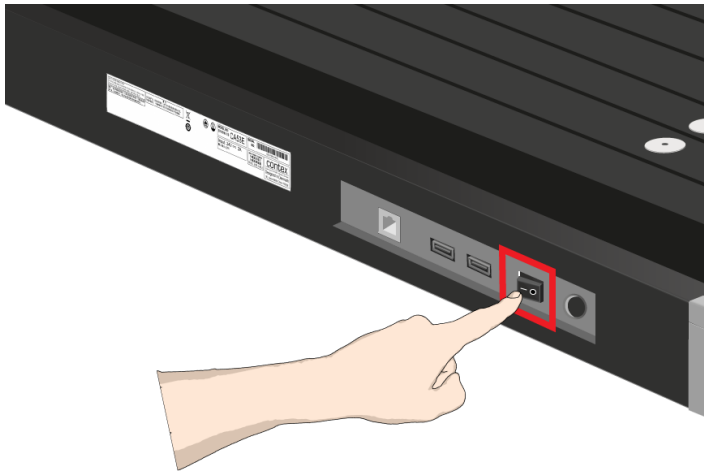

Sleep mode

Sleep mode is an energy saving mode. The scanner cannot scan when in the *Sleep* mode. When first powered on the scanner is set to automatically go into *Sleep* mode after a preset period of inactivity (idle time). This period of inactivity can be extended or shortened to match your normal workflow.

1. Scroll to select the Settings button 
2. Select *System*, then *Timers*.
3. Press the *Sleep* button to set the idle time.



NOTE: When the scanner main power is ON but in *Sleep* mode, the scanner can be woken by touching the scanner controller screen.

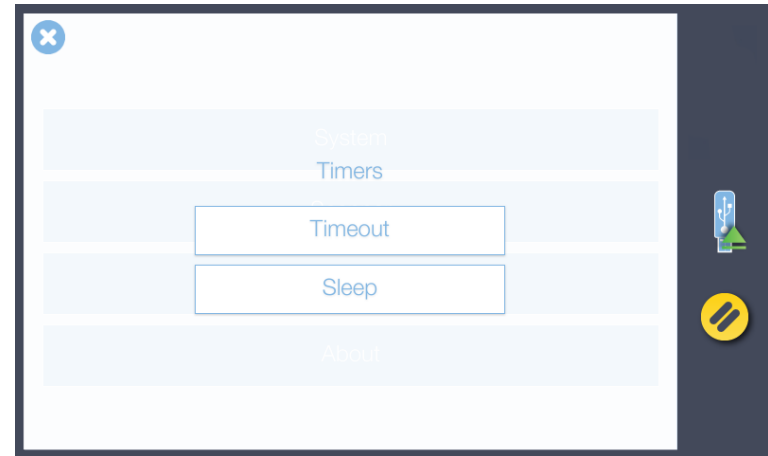





NOTE: *Timeout* is not a power save feature. *Timeout* is a configurable time limit after which the scanner resets back to the default settings for quality, file format, color mode and scan area ready for the next user.

Scanning

Basic steps

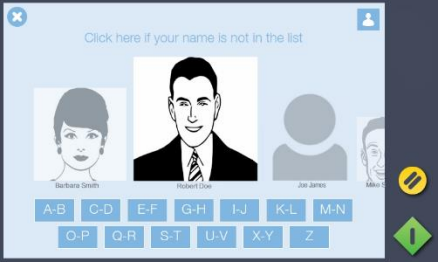
Scanning with IQ FLEX is easy. Scan to USB memory sticks, email accounts, to your own PC and even to personal cloud services. Here's how to set up and send your scans.

<p>1</p>  <p>Load a document</p> <p>Position the document face down with its top edge against the raised alignment guide on the left side of the scan surface.</p> <p>See the section <i>Loading Documents</i></p>	<p>2</p>  <p>Select a Scan destination</p> <p>Scan to USB memory sticks, email accounts, to your own PC and even to personal cloud services.</p> <p>See the section <i>Scan Destinations</i></p>	<p>3</p>  <p>Select user and enter PIN*</p> <p>This step is only required when scanning to your PC or to a cloud service. The list shows all users that have the scan client installed on their PC.</p> <p>*PIN will only be required if setup by the user in Context LINK</p> <p>See the section <i>Context LINK scan client</i></p>	<p>4</p>  <p>Choose your scan settings</p> <p>Select document type, scan quality, file format or press the green button and simply use the default settings.</p> <p>See this section for details</p>	<p>5</p>  <p>Press the button</p> <p>Press the green button to start scanning</p>
---	---	---	---	--

Scan preparation

23 Open the scanner lid

Open the lid of the scanner lid to expose the scan area (glass plate).



 **NOTE:** Always ensure the glass is clean and protected from metal objects that might scratch it.

Normal scan mode

24

Normal Scan Mode

NORMAL – For scanning standard and non-standard size documents using automatic document size detection or manually input dimensions. Inputting exact manual paper sizes requires Nextimage software option.

When scanning portrait oriented originals place the document on the glass **FACE DOWN** with the long edge aligned parallel to the long edge of the glass. Sizes up to A2 or C size can be scanned in this way.

For landscape oriented originals place them on the glass as above and rotate them using the Nextimage scan editor or...

place them short edge parallel to the long edge of the scan glass and left justified against the ruler and select the 'L' Landscape paper sizes. The Oversize Wizard is used to scan larger Landscape paper sizes – see the section on Oversize Scanning document placement later in this guide.



NOTE: The lid should be closed before scanning is started.

Oversize scan mode

25

Oversize Scan Mode

OVERSIZE – For documents up to A1. Oversize places documents on the glass in two operations allowing the scanner to see the whole of the document.

(See later in this guide for more detailed instructions)

IQ FLEX has three open lid positions:

- 30° angle – for oversize scanning (allowing paper to exit rear)
- 60° angle – for access during normal and book mode scanning
- Upright – for lid removal or lid height adjustment

Oversize Input size / Paper size requirements:

- Original must be rectangular
- Paper Size Width is Original Width $\pm \frac{1}{2}$ " (12mm)
- Paper Size Length is Original Length $\pm \frac{1}{2}$ " (12mm)

An onscreen Oversize Wizard instructs the user on how to place the document during Oversize scanning.



NOTE: All items to be scanned must be placed face-down on the scan glass and the lid closed before scanning is started.

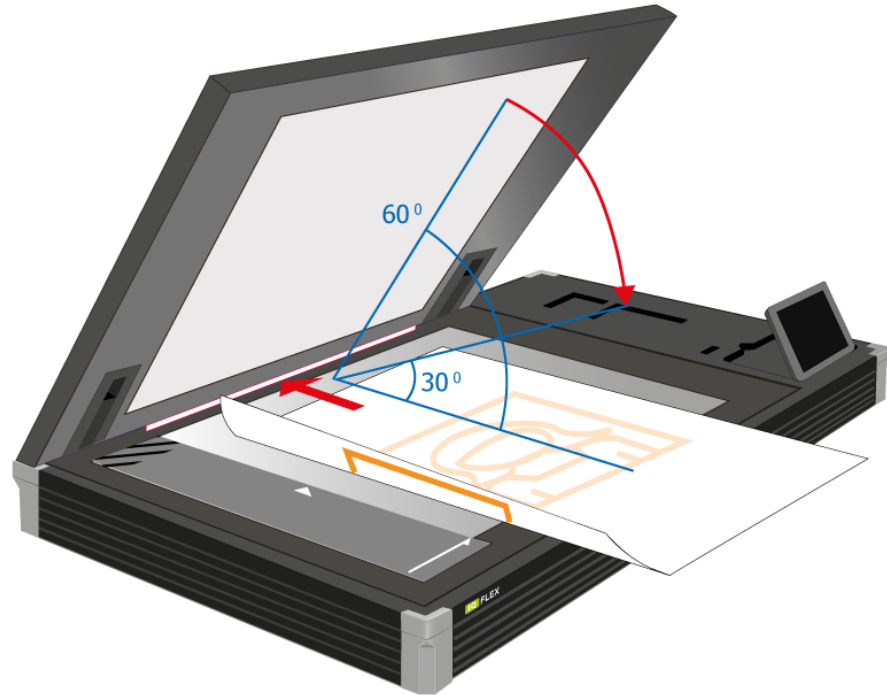

Book scan mode

26

Book Scan Mode

BOOK – For books and catalogues. Select the Book scan option (standalone or using Nextimage software option).

Automatic book size detection requires Nextimage software option. For more details see the book positioning section later in this guide.

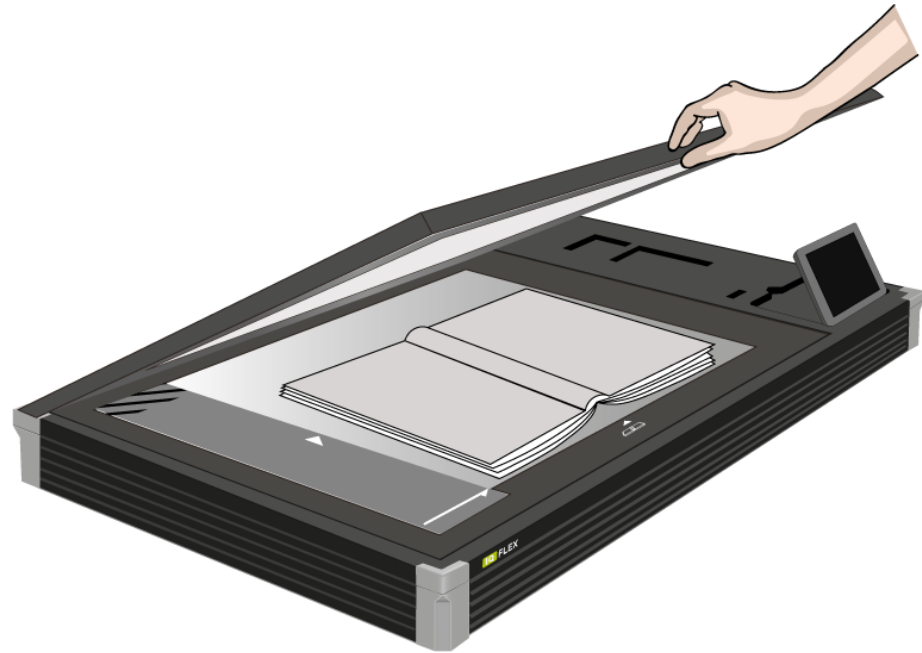

NOTE: Books must be placed face-down on the scan glass with the spine in line with the book icon and the lid closed before scanning is started.

Adjusting the lid for thick originals

27

Raising the Scanner Lid

For thick books and originals it may be necessary to raise the lid to ensure the lid remains level during scanning and prevents unwanted ambient light from entering the scan area.

Raise the lid by lifting the lid at the rear corners near to its hinges. You may prefer to fully open the lid into the vertical position to do this and then lower it back down again.

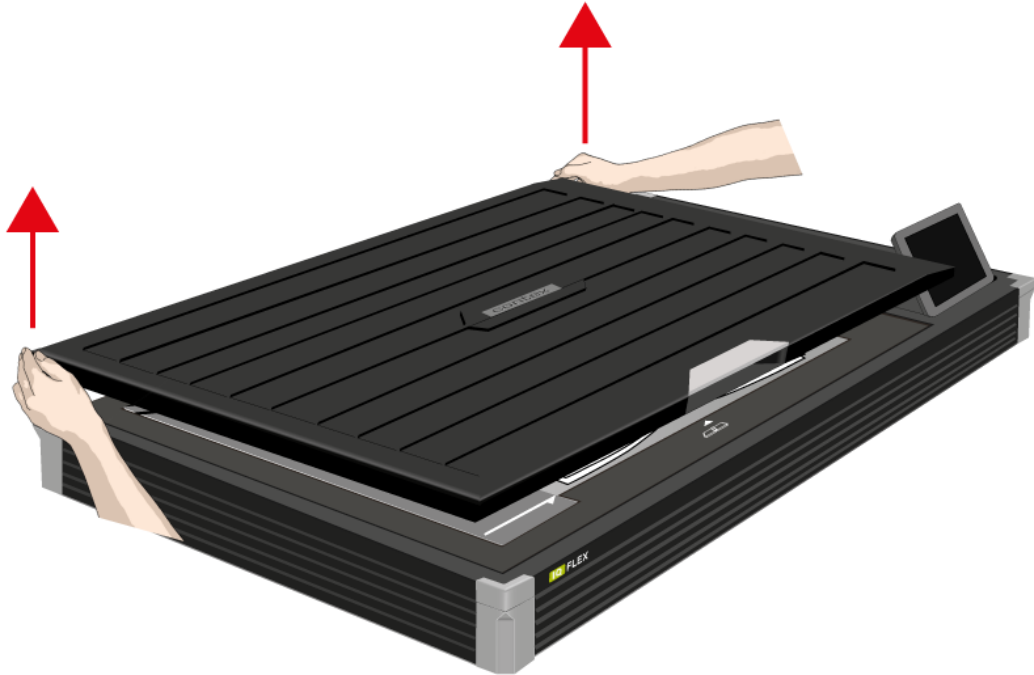

NOTE: Always remove a heavy document from the scanner glass area after scanning and return the lid to its normal paper position height.

Positioning originals

28

Alignment positions

Position A – Oversize scanning (Wizard enabled two-stage scanning). Use this position to scan documents positioned long-edge against the ruler. Accepts documents up to 841mm long by 594mm wide (A1). Requires the Nextimage software option. See separate section for more details.

Position B – Centered (Normal) scanning with automatic size detection. Use this position to have the size of the document detected automatically. Place the center line of the document in line with the white triangle on the ruler. Alternatively select a standard size from pull-down menu or enter the dimensions manually (as above).

Position C – Corner (Normal) scanning with non-automatic sizing. Select the size from the paper list or enter the dimensions manually. Align the document edges against the raised ruler guide at the left side of the scanner glass and the long white arrowed line on the guide. Requires the Nextimage software option.

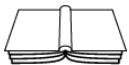
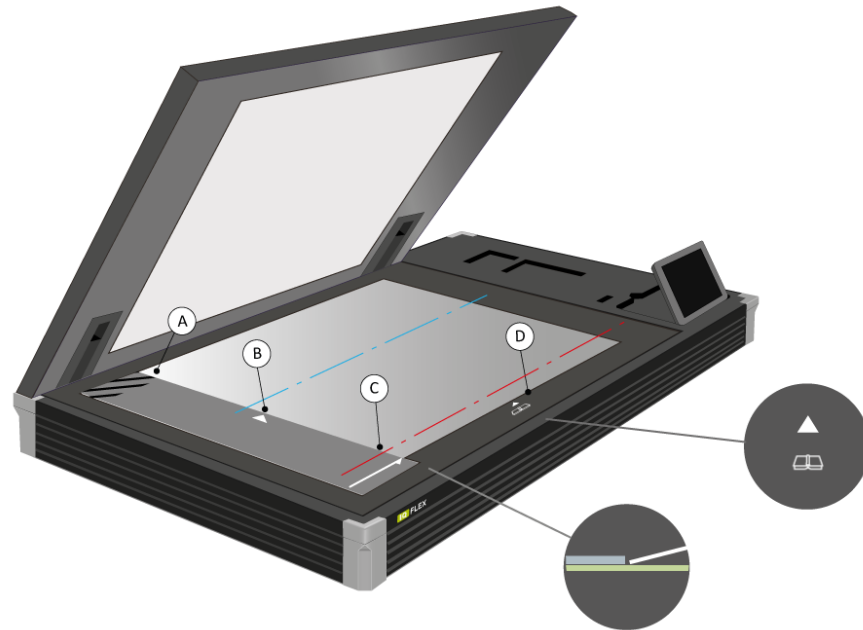

Position D – Book scanning. Place the book on the glass with the book spine in line with the book icon and the long white line arrowed line on the guide.

Paper sizes and guides

29

Scan Guides

Guide markings are read from the left looking up the long axis of the scanner (not from the front of the scanner).

The guide icons refer to documents required as portrait scans. Standard size documents A4 to A2 or A to C should be placed on the glass face-down with long-axis left-to-right, centered at the tick mark. Use Nextimage settings from inside the red box (see below).

Documents required as landscape (e.g. CAD) can be scanned as portrait and manually rotated in software. Alternatively position the document long-side against the next largest size e.g. for A4 (L) inside the A3 markings. Select A4 (L) in Nextimage.

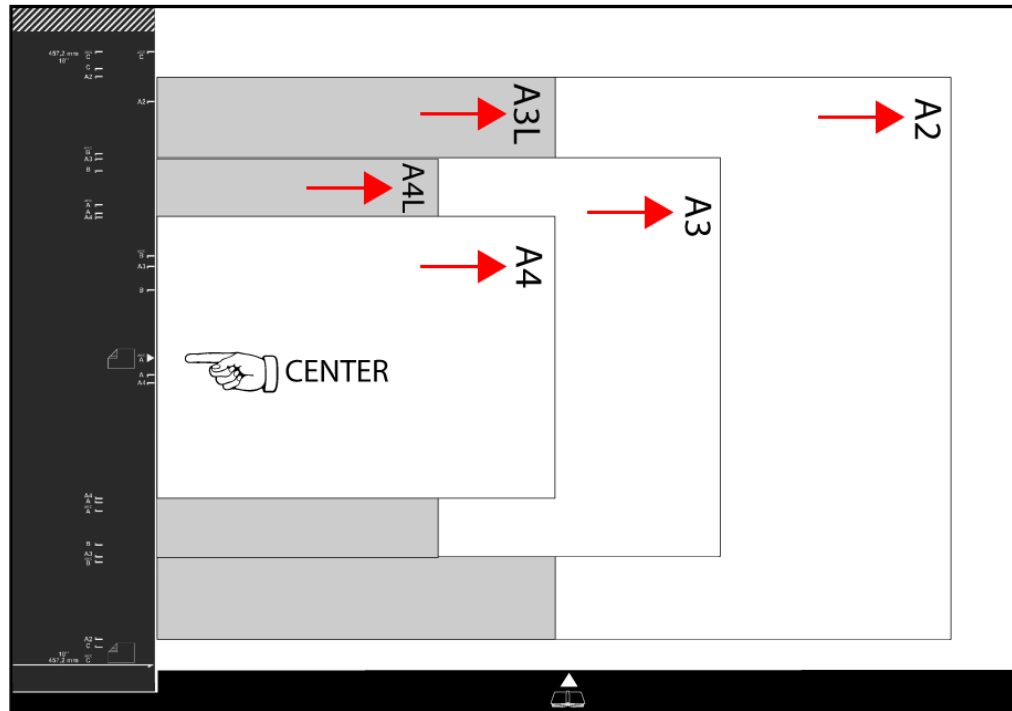
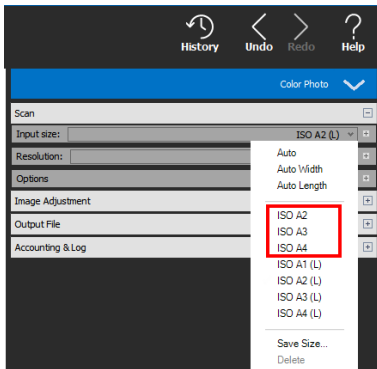

NOTE: A2 (L) and A1 (L) documents are scanned long-side against the guide in two stages using the Wizard. See the Oversize scanning section.

30

Oversize scanning settings (scanner)

From Settings select Area then select Manual.



Next type in the Width of the oversize document followed by the Length (length shown).

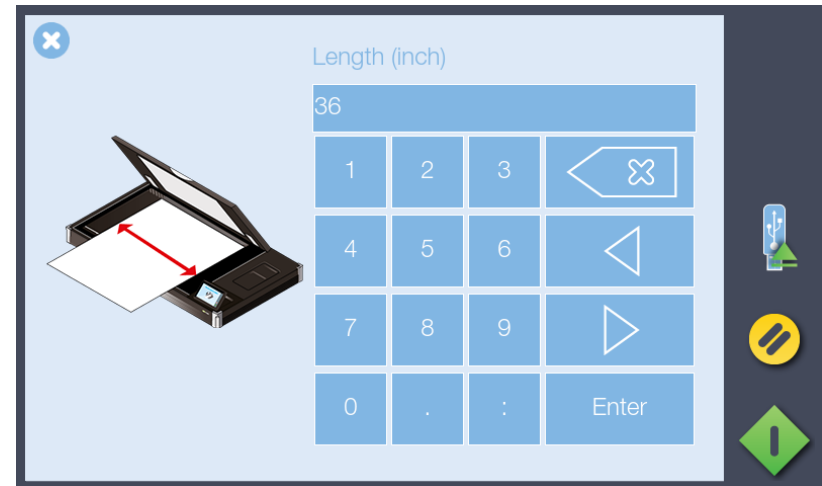

When scanning is started the Wizard will guide the operator through the scanning process.



NOTE: Oversize Input size / Paper size requirements

- Original must be rectangular
- Paper Size Width is Original Width $\pm \frac{1}{2}$ " (12mm)
- Paper Size Length is Original Length $\pm \frac{1}{2}$ " (12mm)

31

Oversize scanning Wizard (scanner)

1. Place the long-edge of the document against the guide edge with the top corner meeting the lower corner of the hatched area (inset). The document lower section can hang over the front of the scanner.

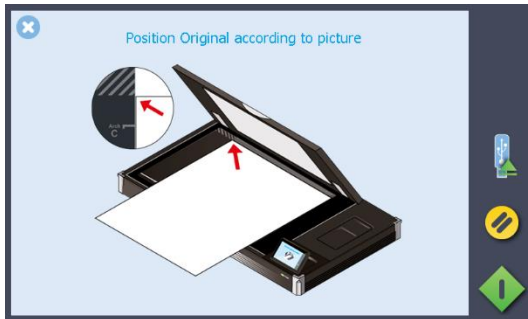

2. Now close the lid and press the Wizard scan button on the computer or use the scan button on the scanner screen to begin the first scan pass.

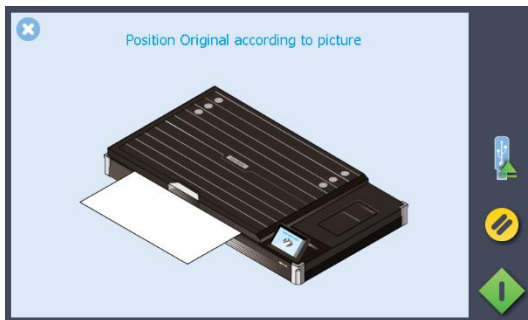

3. Now open the scanner lid to 30° and move the document toward the hinge of the lid so that the lower-left corner lines up with the long arrow (inset) at the front and the opposite end passes out through the scanner at the back.

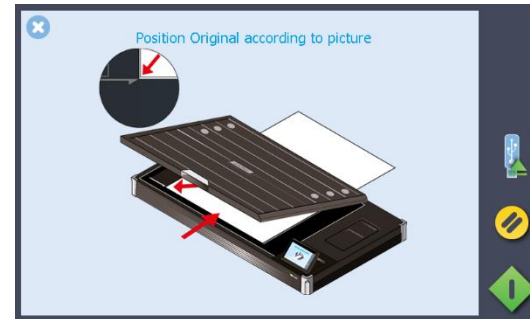

4. Now close the lid and press the scan button to complete the scan.

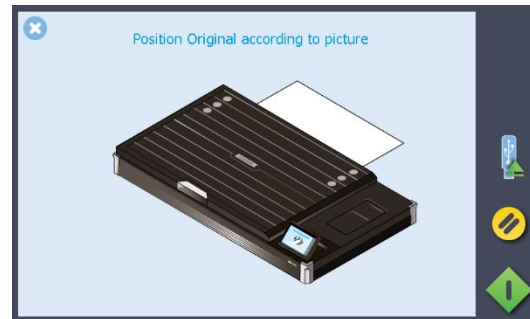

Scanning oversized documents

32

Oversize scanning settings (Nextimage)

In the scan input size settings select one of the (L) paper sizes or a manual paper size dimension that is larger than 24" to switch on Oversize. When scanning begins the Nextimage Wizard will appear in the software user interface to guide the operator through the scanning process.

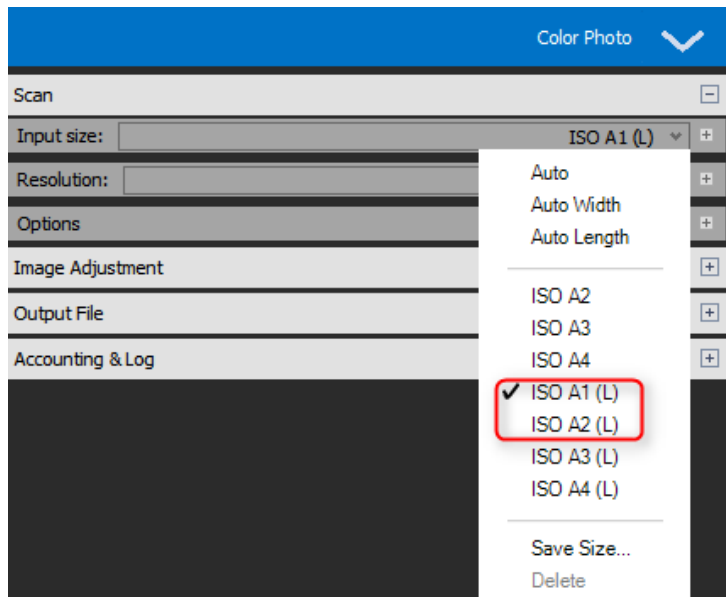

The normal load position setting is ignored when scanning in Oversize mode.

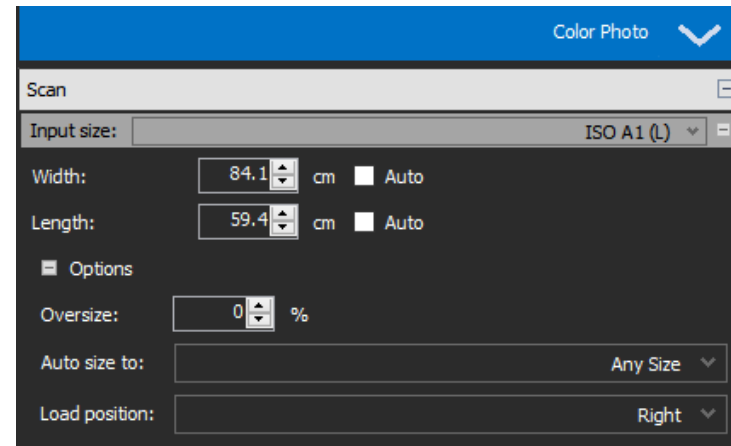

NOTE: Oversize Input size / Paper size requirements

- Original must be rectangular
- Paper Size Width is Original Width $\pm \frac{1}{2}$ " (12mm)
- Paper Size Length is Original Length $\pm \frac{1}{2}$ " (12mm)

Positioning oversize documents

33

Oversize scanning Wizard (Nextimage)

1. Place the long-edge of the document against the guide edge with the top corner meeting the lower corner of the hatched area (inset). The document lower section can hang over the front of the scanner.

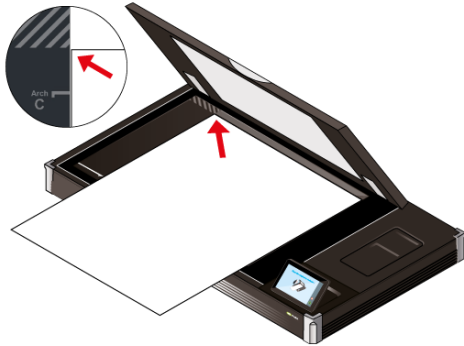

2. Now close the lid and press the Wizard scan button on the computer or use the scan button on the scanner screen to begin the first scan pass.



3. Now open the scanner lid to 30° and move the document toward the hinge of the lid so that the lower-left corner lines up with the long arrow (inset) at the front and the opposite end passes out through the scanner at the back.

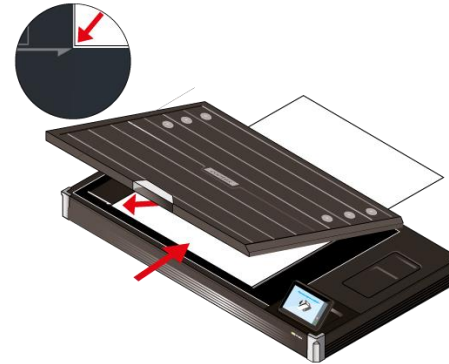

4. Now close the lid and press the scan button to complete the scan.



Book positioning

34

Book scanning book positioning

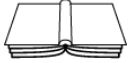

Place the book face down on the scanner glass with the spine of the book centered in line with the white pointer and the lower edge in line with the long white arrow on paper size guide.



NOTE: Thick books can be accommodated in the scanner by raising the lid hinges before lowering the lid. This will ensure the scanner white background remains parallel with the object to be scanned and operates to prevent light from outside and spoiling the scan.

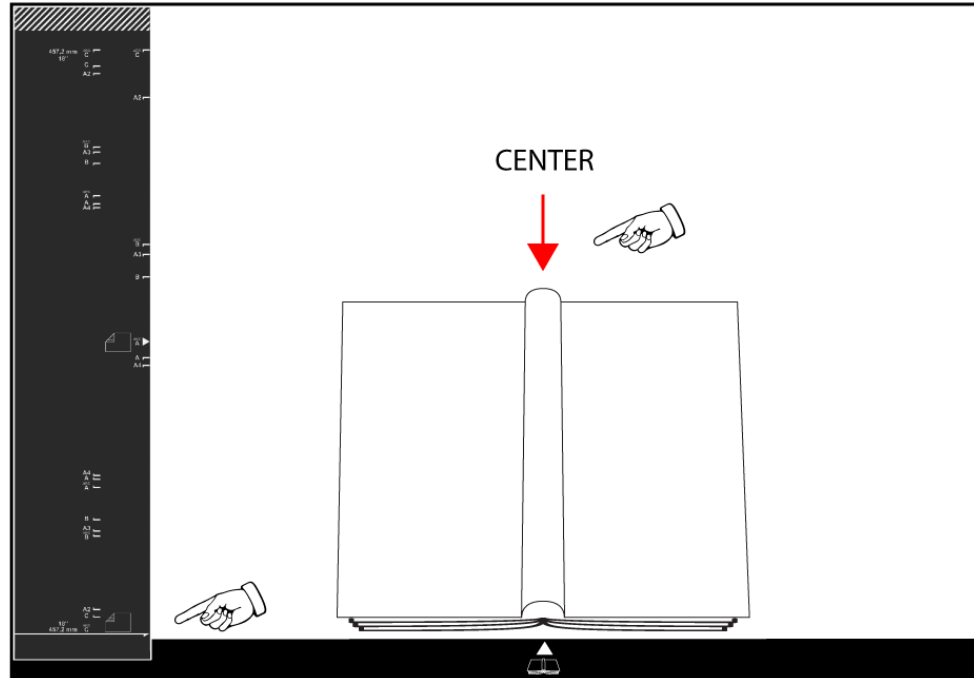

Book scanning without software

35

Book scanning using the scanner

At the scan settings screen touch Method and change it to Book.

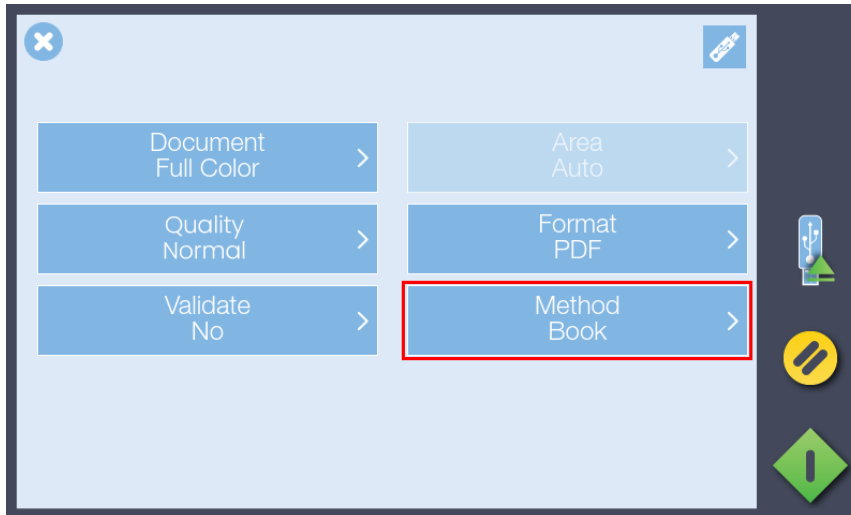

Now lower the lid and press the scan button.

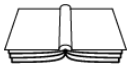

NOTE: Thick books can be accommodated in the scanner by raising the lid hinges before lowering the lid. This will ensure the scanner white background remains parallel with the object to be scanned and operates to prevent light from outside and spoiling the scan.

The scan will be saved to the chosen destination e.g. USB stick, network location or cloud (requires use of Context LINK).

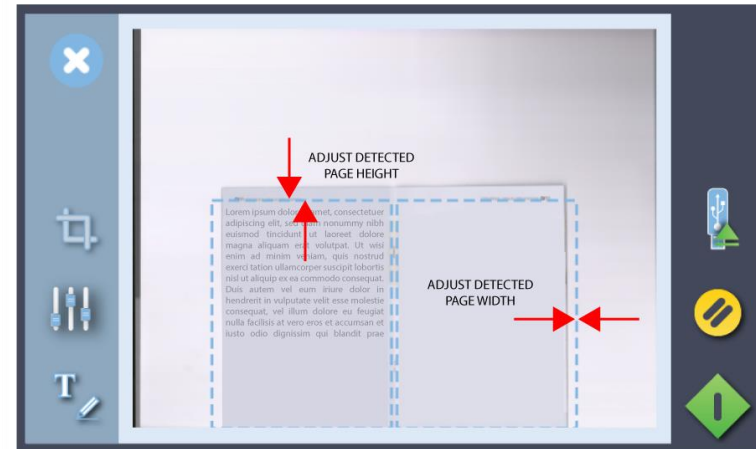

Touch the margins around the book to correct them if required

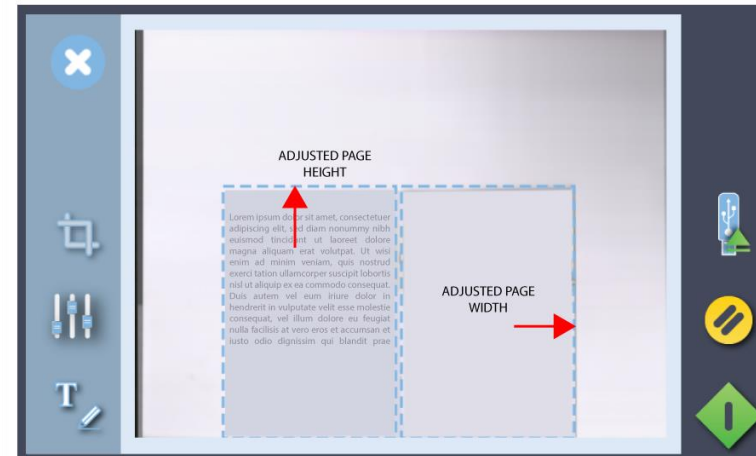

Now press the green button to finish the scan

Book scanning using Nextimage

36

Book scanning using Nextimage

In Nextimage click the Book icon. The icon will change to a gray background. Choose Multipage if required.

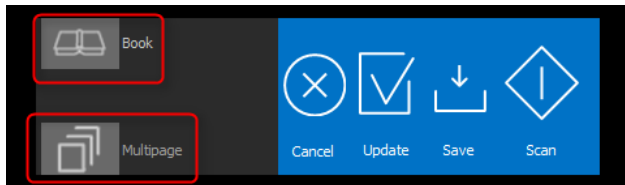

Now place the book face-down on the scanner glass with the book spine in-line with the white arrow and book icon along the lower edge of the scan area. Set the NI input size for Auto. Now lower the lid and press the scan button.

Nextimage will attempt to automatically determine the size of the combined pages on the scanner. Adjust the crop boundaries, spine removal width and position of the scan if necessary then click Update. To finish a multipage session click Save.

A single scan will display in Acrobat as two separate pages when Multipage is selected.

When Nextimage is used with IQ FLEX no user input is required at the scanner display. During Nextimage scanning the scanner display will show 'Scanner used by IP xxx.xxx.xxx.xxx.'

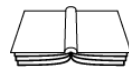
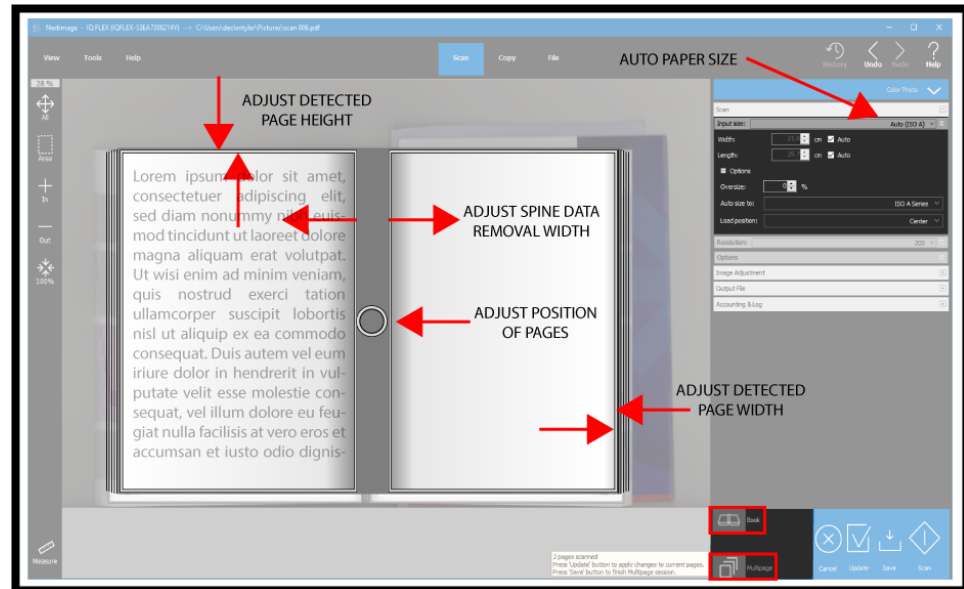

NOTE: Thick books can be accommodated in the scanner by raising the lid hinges before lowering the lid. This will ensure the scanner white background remains parallel with the object to be scanned and operates to prevent light from outside and spoiling the scan.

37

Closing the lid

Carefully close the lid over the document without disturbing its position and alignment.

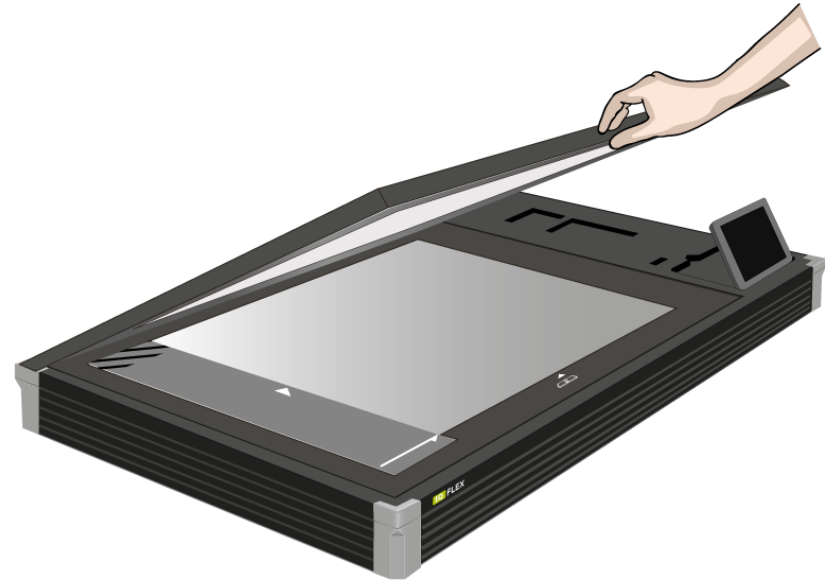

NOTE: Thick documents will probably require the lid height to be adjusted. See the Lid Adjustment section earlier in this guide.

Further notes about input size

The *Input size* defines the scan area. Enter the input size in your application's input size dialogs.

3 ways to set find and set the input size:

1. **Use automatic size detection** - The scanner will detect the edges of the document and calculate the input size for you.
2. **Set a standard size** - common standard sizes are marked on the left side of the scan area at the scanner alignment bar. Use these markings to determine which standard size matches the original and then select that size in the application's *input size* dialog.
3. **Set the size manually** for irregular sizes. To measure your document - use the scanner's ruler on the edge of the scanning area. Enter your width measurement in the *width* setting field in your application's *input size* setup dialog. You can measure and set a *length* value or choose automatic length detection.

Using the USB socket

38

Scanning to USB memory

IQ FLEX will accept any USB memory stick in the size range 4GB to 128 GB formatted for FAT-32.

- Insert the USB stick into the USB slot on the top of the scanner.
- Select the USB memory stick option in the scroll menu.
- Choose your settings then press the scan button. The DCIM folder is the always the default location for scans to memory stick.

After scanning be sure to touch the USB safe-ejection button if displayed onscreen before removing the memory stick



Scanning to email

39

Scanning to email

Send the scan to an email address.

- Press the email option.
- Enter the target email address using the onscreen keyboard.
- Choose your settings then press the scan button.



NOTE: Set up the scanner outgoing email parameters before using this option. See section *Installation - Enter your email server settings*.



Scanning thick media

40

Thick media

You may need to scan documents and drawings printed or pasted on thick media such as cardboard, foamboard, Gatorboard etc.

- Your flatbed scanner can accommodate originals up to 1.5" (38 mm) thick while still allowing you to close the cover.
- You can also scan very thick originals by placing the original on the scanner bed and leaving the cover completely open.



NOTE: Thick documents can be accommodated in the scanner by raising the lid hinges before lowering the lid. This will ensure the scanner white background remains parallel with the object to be scanned and operates to prevent light from outside spoiling the scan.

Scanning to personal PC and Cloud destinations

To use the following destinations **Contex LINK**  client software must be installed and configured correctly on your PC. The PC must be on the same network (LAN) as the scanner.

When you have installed and configured the Contex LINK client software on your PC, the scanner will detect your PC on the LAN, and add you to the user list on the scanner. The Contex LINK client facilitates scanning to the PC and to the cloud services that you have connected to through the client. You can also scan to other user's PCs or their cloud services if you know their PIN codes. This is especially useful for sharing scans during projects.





NOTE: See details about setting up Contex LINK and the cloud service connections in the section *The Contex LINK scan-client*.



Scan to your PC

1. On the scanner, select the User icon  and select yourself or another user from the list.
2. Enter your PIN code if prompted (NOTE: *PIN will only be required if setup by the user in Contex LINK).
3. Configure your scan settings then scan.
4. To locate the scan on your PC;

- Press the Contex LINK icon on your system tray to open the Contex LINK scan client 
- Select the folder icon at the top of the Contex LINK scan client interface to find the scans sent to your PC / User 



Scan to a cloud service – Box, Dropbox, Google Drive, OneDrive

1. On the scanner screen, scroll and select the relevant cloud service option.
2. Select the relevant user from the list.
3. Enter your PIN code if prompted (NOTE: *PIN will only be required if setup by the user in Contex LINK).
4. Configure your scan settings then scan.
5. Locate your scan in the local or online folders for the cloud service you selected.

The scans default to a folder named “Contex Solutions”. In Dropbox this folder will be in the “Apps” folder and in all other clouds it will be in the root folder.



Scan to file settings

Setting	What does it mean?
Document	<p>The type of document you are scanning</p> <p>Full Color Color photos, posters etc. Grayscale Photo or image with gray shades Color CAD/Map Color line drawing or map Grayscale CAD/Map Line drawing or map gray shades Black & White Line drawing or map solid black lines</p>
Area	<p>Determines the scanner capture area</p> <p>Auto Scanner detects the size automatically. All Scan the full width of the scanner. Manual User input of scan width and scan length</p>
Quality	<p>Determines the file size by changing the scan resolution</p> <p>Low 150 dpi resolution where speed counts most Normal 300 dpi resolution for most common tasks High 600 dpi resolution for higher quality. Slower Ultra-High 1200 dpi highest resolution. Slowest. Big files</p>
Format	<p>The file type of the output file: TIF, JPG, PDF, PDF/A with percentage quality (default is 80).</p>
Validate	<p>Open a scan preview for validation or to add small edits before saving it to file.</p> <p>YES Opens the preview NO Bypasses the preview</p> <p>Validation options: SELECT– select validation entity CROP – drag green border, press green button to save DRAW – add freehand lines and markups. TEXT – add text to the image. ADJUST – change brightness to improve copy</p>
Method	<p>Choose to scan normally or use book scanning</p> <p>Normal Normal or Oversize scan mode Book Book scan mode</p>



MENU to change: Document Color, Scan Area, Scan Quality, File Format and Validate SCAN options.











Full Color (selected), B/W Grayscale, Color CAD/GIS and B/W Grayscale CAD/GIS options for scanning a Document to file.







Color Validation (draw line)

Preview, Adjust, Crop and Annotate

Validate opens a preview of the document before it is sent to file. Use this screen to clean up the scanned image by cropping or adjusting the brightness. Also add freehand lines and text annotations to the scanned image if required.

-  Proceed or Save validation changes
-  Zoom the onscreen image
-  Remove image data outside of the crop lines
-  Adjust scanned image using white and black levels (improve brightness)
-  Go to annotation screen to add text and/or freehand lines
-  Return to validation screen from annotation screen
-  Select text for change or deletion. See note below
-  Cancel validation changes

Active Edit Controls (appear when annotation selected)

- | | | | | | |
|--|--|--|--|--|--|
|  |  |  |  |  |  |
| Increase line thickness | decrease line thickness | increase text size | decrease font size | change text or color | |

 **NOTE:** Pressing the green button stores any validation edits permanently into the scan file. Changes **cannot be reversed** after leaving the validate screen.

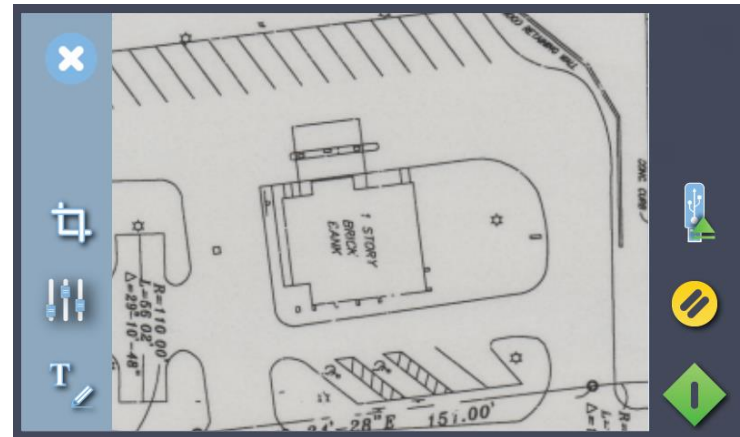

(Above) Validation Screen with Cancel, Crop, Adjust and Annotate controls

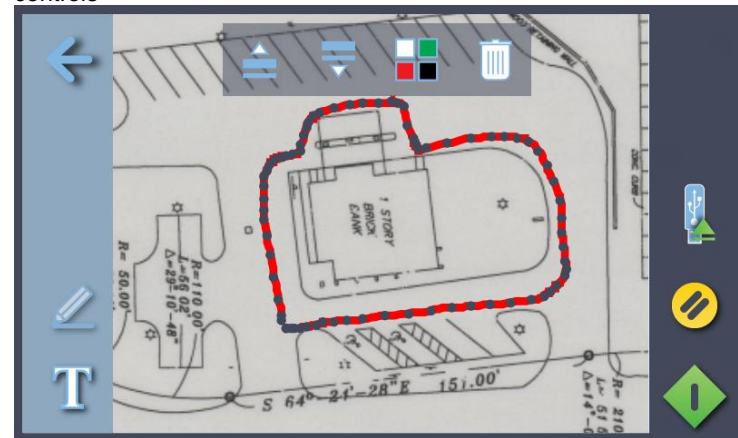

Adjust Screen with Return, Freehand Line (selected) and Text controls

Color Validation (add text)

Preview, Adjust, Crop and Annotate

Validate opens a preview of the document before it is sent to file. Use this screen to clean up the scanned image by cropping or adjusting the brightness. Also add freehand lines and text annotations to the scanned image if required.

Annotations and changes are temporary until the green button is pressed.

Annotations can be selected by touching them. Once selected annotation objects can be moved, re-sized, re-colored or deleted.



NOTE: Pressing the green button stores any validation edits permanently into the scan file. Changes cannot be reversed after leaving the validate screen.

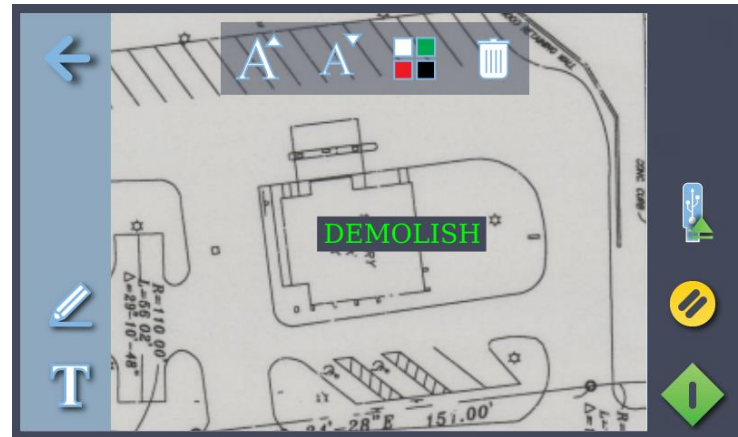

(Above) Annotation Screen showing Return, Freehand Line and Text (selected) controls

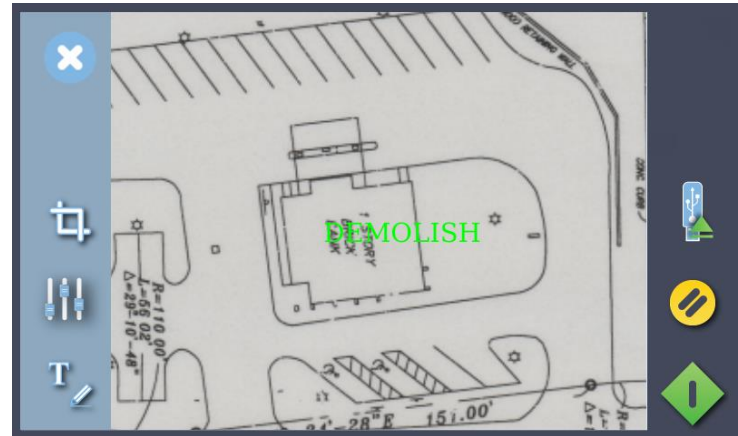

Validation Screen showing Cancel, Crop, Adjust and Annotate controls with added text annotation

Color Validation (change brightness)

Preview, Adjust, Crop and Annotate

Validate opens a preview of the document before it is sent to file. Use this screen to clean up the scanned image by cropping or adjusting the brightness. Also add freehand lines and text annotations to the scanned image if required.

Color of annotations is not affected.



X CANCEL brightness adjustment

Moving top slider down **CHANGES NEAR-WHITE COLORS TO WHITE**

Moving lower slider up **CHANGES NEAR-BLACK COLORS TO BLACK**

✓ ACCEPT BRIGHTNESS CHANGES and return to Validation screen



NOTE: Pressing the green button stores any validation edits permanently into the scan file. Changes cannot be reversed after leaving the validate screen.



(Above) Validation Screen with annotated image before adjustment

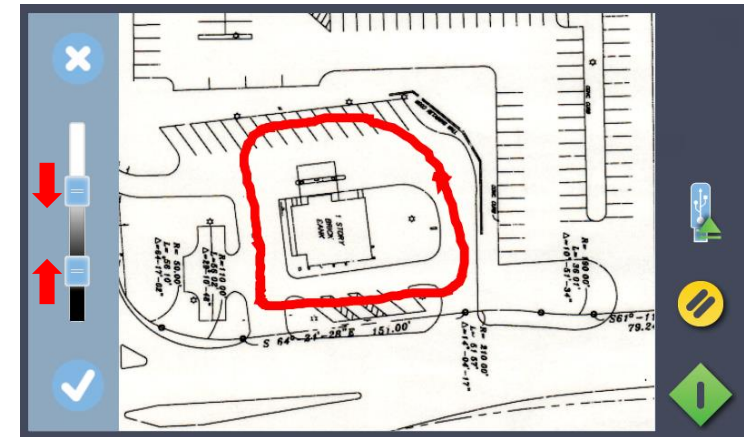

Adjust Screen adjusted for brightness

Gray Validation (change brightness)

Preview, Adjust, Crop and Annotate

Gray level of annotations is not affected.



X CANCEL brightness adjustment

Moving top slider down **CHANGES NEAR-WHITE GRAYS TO WHITE**

Moving lower slider up **CHANGES NEAR-BLACK GRAYS TO BLACK**

✓ ACCEPT BRIGHTNESS CHANGES and return to Validation screen



NOTE: Pressing the green button stores any validation edits permanently into the scan file. Changes cannot be reversed after leaving the validate screen.

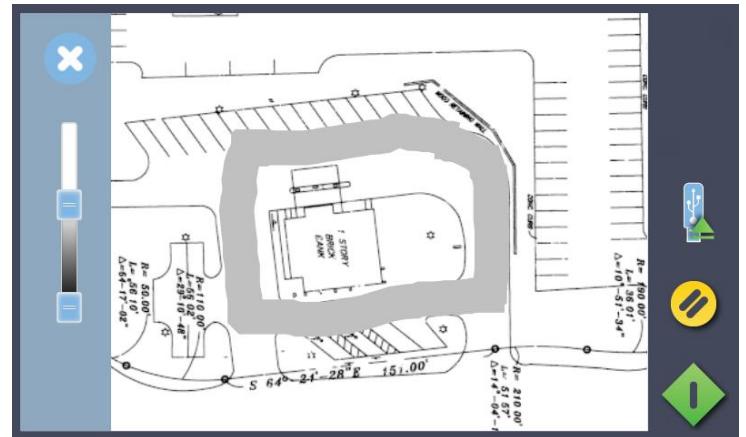

(Above) Adjust Screen showing default brightness setting

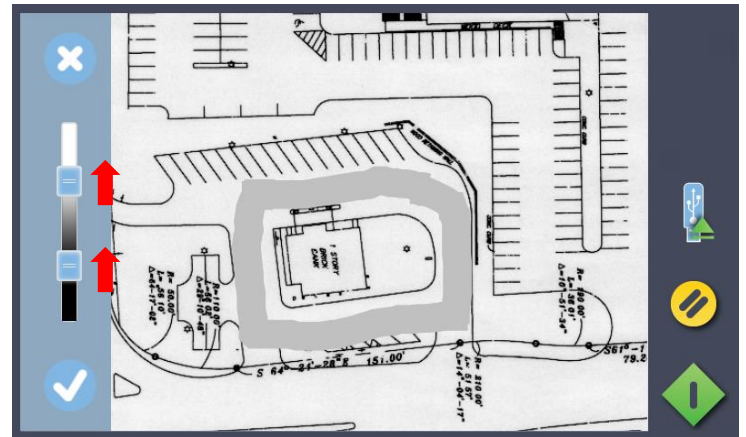

Adjust Screen showing darker lines and darker background

Black and White Validation (darken lines) Preview, Adjust, Crop and Annotate

Black level of annotations is not affected.



CANCEL brightness adjustment

Moving slider down **DISPLAYS MORE BLACK LINES.**
WHITE areas are not affected

ACCEPT BRIGHTNESS CHANGES and return to Validation screen



NOTE: Pressing the green button stores any validation edits permanently into the scan file. Changes cannot be reversed after leaving the validate screen.

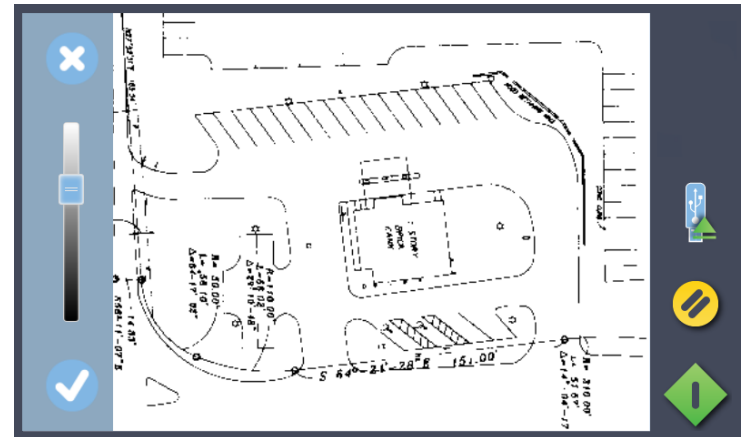

(Above) Adjust Screen showing weak black line density

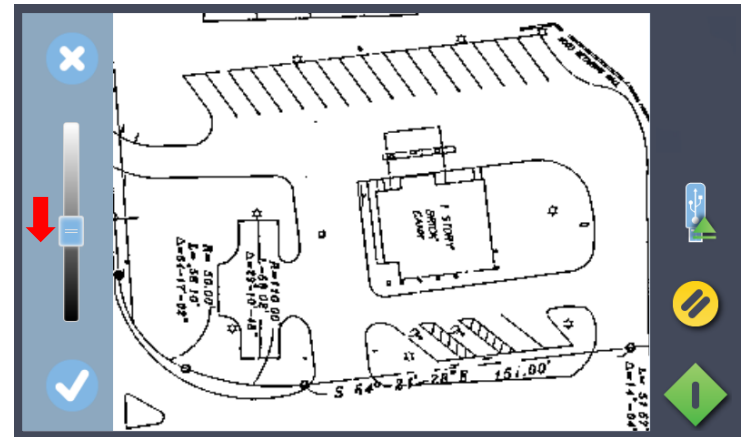

Adjust Screen showing stronger black line density

Context LINK scan client

The Context LINK scan client makes it easy to share one scanner in a user group. Users can create personal profiles to store their own file destinations and really personalize their use of the scanner.

Context LINK is a simple client software application installed on the user PC. Once configured the scanner will find the PC client and then handle all connections back to the user pc and to any cloud accounts such as Box, Dropbox, Google Drive and OneDrive that the user wants to connect to.

41 Install Context LINK

At the scanner:

1. Locate the scanner network IP address:  -> About
Wired LAN IP address

Wired LAN IP address

Wireless Wi-Fi IP address

At the computer:

Use an internet browser to download the Context LINK software from the scanner or from the internet.

1. Go to <http://<your scanner IP address>> or <http://www.context.com/IQ-FLEX> and click on the blue link icon or 'click here to install'.
2. Install the software.
3. The Context LINK icon will appear in your PC programs and system tray areas.
4. Click on the  icon to open the program.

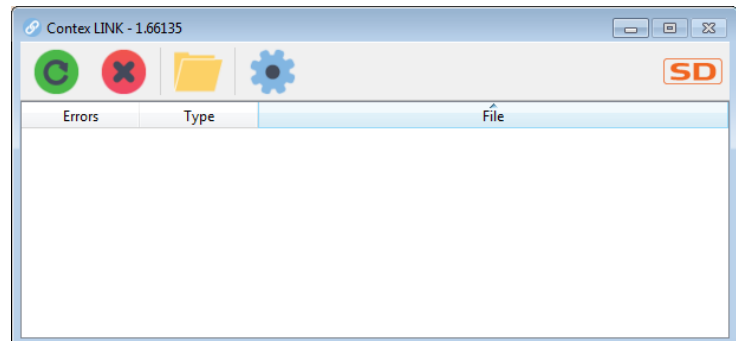
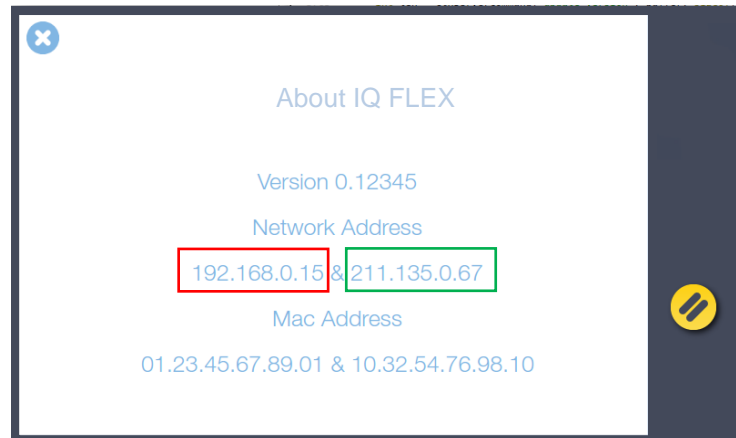

Scanning to the cloud

42

Connect scanning to cloud services

1. Start Contex LINK on your PC and press the setup icon 
2. Enter your name, email address.
3. Enter a personal PIN code of your choice if you want to enforce authentication at the scanner (optional).
4. Select your language preference.
5. Connect to your personal cloud services:
 - Select a cloud service by pressing its icon e.g. the Dropbox icon.
 - The service's authentication screen will be displayed.
 - Enter your credentials to authenticate your cloud service account and create the connection between the scanner and the cloud service.
 - Repeat for any other cloud services you subscribe to.
 - The connection setup will be saved and applied for all future scans.



The ContexLINK pc screen

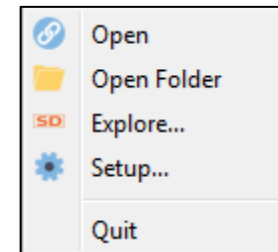





The ContexLINK right-click menu

Copying

The basic steps of copying

Making copies with the IQ FLEX is easy. Here's how you make copies:

<p>1</p>  <p>Loading a document</p> <p>Position the document face down with its top edge against the raised alignment guide on the left side of the scan surface.</p> <p>See the section on <i>Loading Documents</i></p>	<p>2</p>  <p>Select the Copy option</p> <p>In order to make copies a printer and media profile for used media must be set up in the scanner settings.</p> <p>See the section <i>installation - Set up your printer</i></p>	<p>3</p>  <p>Choose your copy settings</p> <p>Select document type, scan quality, file format or press the green button and simply use the default settings.</p> <p>See this section for details</p>	<p>4</p>  <p>Press the button</p> <p>Press the green button to start copying</p>
---	---	---	---

Copy settings

Setting	What does it mean?
Document	<p>The type of document you are copying</p> <p>Full Color Color photos, posters etc. Grayscale Photo or image with gray shades Color CAD/Map Color line drawing or map Grayscale CAD/Map Line drawing or map gray shades Black & White Line drawing or map solid black lines</p>
Quality	<p>Determines the copy output quality</p> <p>Draft 150 dpi resolution for fast copies Standard 300 dpi resolution suitable for most copies High 600 dpi resolution for best quality but slower</p>
Area	<p>Determines the scanner capture area</p> <p>Auto Scanner detects the size automatically. All Scan the full width of the scanner. Manual User input of scan width and scan length</p>
Resize	<p>Determines how the copy should be resized(or not)</p> <p>None No resizing in copy Paper Resize to paper size Scale Percentage resize</p>
Media	<p>The type of media or paper you are using</p> <p>The media in the printer. If there is no option that matches your media then you will need to create a media profile. See installation - Set up your printer's media profiles</p>
Copies	<p>The number of copies you want output</p> <p>Select the number</p>
Validate	<p>Open a copy preview for validation and to add small edits before making the copy.</p> <p>YES Opens the preview NO Bypasses the preview</p> <p>Validate options: SELECT – select validation entity CROP – drag green border, press green button to save DRAW – add freehand lines and markups TEXT – add text to the image ADJUST – change brightness to improve copy</p>



(Above) Menu to change: Document Color, Copy Quality, Copy Size, Resize Option, Media Type, Copies and Validate COPY options.











Full Color (selected), Grayscale, Color CAD/Map, Grayscale CAD/Map and Black & White options for scanning to file.

Color Validation (add line)

Preview, Adjust, Crop and Annotate

Validate opens a preview of the document before it is copied. Use this screen to clean up the scanned image by cropping or adjusting the brightness. Also add freehand lines and text annotations to the copy if required. Refer to Scanning section for more details.

-  Proceed or Save validation changes into the copy
-  Zoom the onscreen image
-  Remove image data outside of the crop lines
-  Adjust scanned image using white and black levels (improve brightness)
-  Go to annotation screen to add text and/or freehand lines
-  Return to validation screen from annotation screen
-  Select text for change or deletion. See note below
-  Cancel validation changes

Active Edit Controls (appear when annotation selected)

- | | | | | | |
|--|--|--|--|--|--|
|  |  |  |  |  |  |
| Increase line thickness | decrease line thickness | increase text size | decrease font size | change text or color | delete |

 **NOTE:** Pressing the green button stores any validation edits permanently into the scan file. Changes **cannot be reversed** after leaving the validate screen.

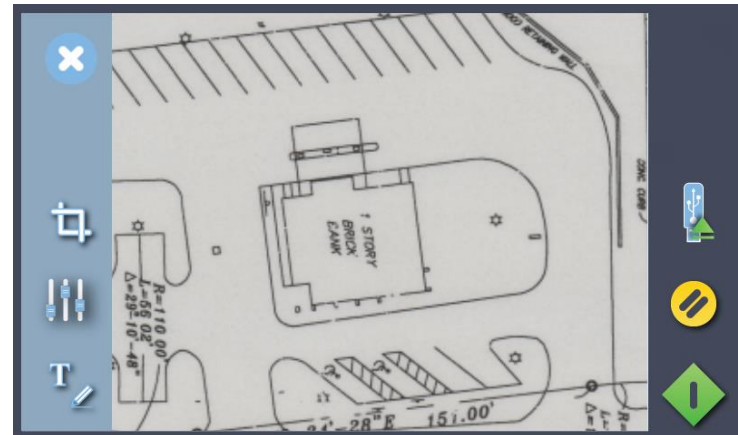

(Above) Validation Screen with Cancel, Crop, Adjust and Annotate controls

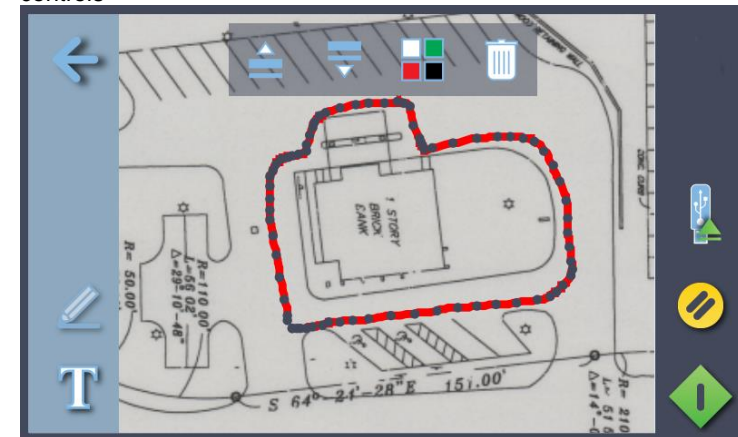

Adjust Screen with Return, Freehand Line (selected) and Text controls

Wi-Fi – Connecting to a wireless network

The scanner will show the wireless networks that are in wireless range of the scanner. Select the wireless network you wish to attach to.

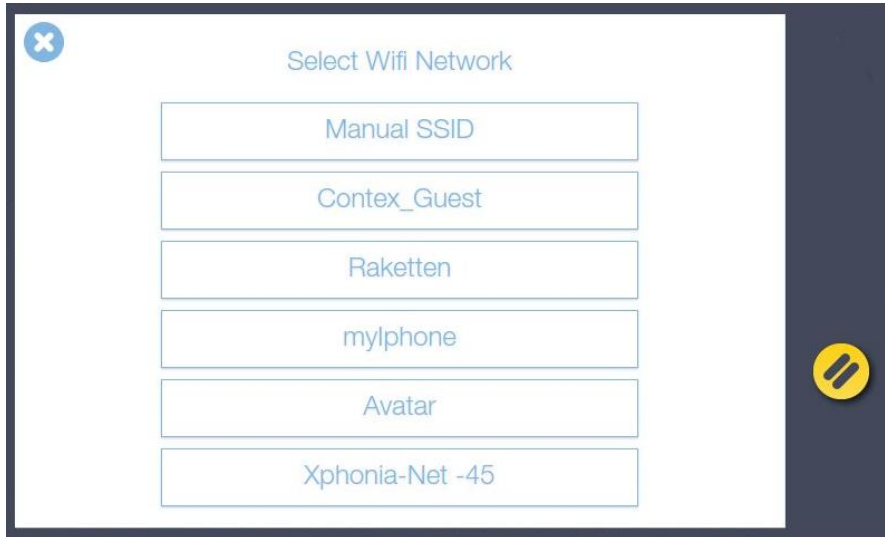

For hidden networks where the SSID (Service Set Identifier) is known but not visible it can be typed in manually using the Manual SSID option.

A password can be used to prevent unauthorised scanner connection to a wireless network. Leave the password line blank and press OK if you do not want to use this option.



NOTE: After inserting the Wi-Fi dongle it can take up to 2 minutes for the scanner to fully detect all available networks and for them to be displayed. Hidden SSID networks are not supported.



Wi-Fi password screen



Manual SSID input screen

Settings and preferences



The IQ FLEX offers a wide range of setting options to match the scanner to your specific needs. Press the *Settings* icon  to reach the available options. The available settings are grouped under **System** settings, **Scanner** settings, **Printer** settings, and **About**.

Options Group	Group	
System	Network	LAN settings - to add the scanning system to the local network. Select DHCP for automatic connection (recommended). Or, contact your network administrator for information. See also Installation - Enter your network settings. You can also view your scanner IP address here.
	Email	Setup the outgoing email server for sending scans to email destinations. Some of the settings, or the need for these will depend on your system's server configuration. Please contact your network administrator for information. See also Installation - Enter your email server settings.
	Language	Select preferred languages for Screen and Keyboard. They do not need to be the same.
	Timers	Timeout is the time the scanner will stand idle before the scanner resets itself to its default settings so that it is ready for the next user. Sleep is the time the scanner can stand idle before going into sleep mode.
	Wi-Fi	Displays Wi-Fi networks in range of the scanner. Use screen touch keyboard to enter SSID, password etc.
	Regional	Set your local date, time, metric system (inch or mm.), and paper series (ANSI, ISO, ISO B, ARCH).
	Password	You can set up a password to control access to the scanner. Leave empty if you don't need password protection.
	Settings	Save settings or reset settings to defaults
Scanner	Update	To update your system software with the latest version. The system will search for a newer version and install through the internet if available.
	Calibrate	Start the Scanner Calibration Wizard. See section Maintenance – Scanner Calibration for instructions and more details
	Paper Handling	Eject paper to rear or front
	Service	Distribute the log data from the scanner for service and support. Send info by email to support@contex.com or Save info to USB.
Printer	Upgrade	Scanner activation – scan the license certificate
	Printer	Displays make, model, IP address, media, media profile and busy status of the selected printer
	Setup	Enter the printer IP address – the scanner will detect the printer on the LAN and connect. Contact your IT support for information.
	Media Profile	Create a media profile for the chosen media by printing the color then scanning it using the scanner.
About	Compensate for printer margins	Make the scanner account for outer paper edges that cannot be reached /printed on by the printer. Ensures margins are not increased or the scale of the copy is affected.
		Information about your current scanner firmware, software versions and network addresses

WIDEsystem

Connect a LAN cable and power on the scanner. After installing the software WIDEsystem will show a grey icon in the system tray area (near Windows clock).

Right-click the icon and click Restore WIDEsystem

The Status tab will show 'No scanners found'

Go to the Network tab and click Add... and follow the prompts to start the scanner detection Wizard.

When you see your scanner appear in the list click Next. The wizard will now complete and display a message that the scanner IQ FLEX 53Dxxxxxxx has been successfully installed. The Status and Info pages will now show information from the scanner.

An orange WIDEsystem icon indicates a connected scanner.

Nextimage

Start Nextimage software from the icon or the program menu. During startup Nextimage will begin searching and then connect to the scanner found by WIDEsystem. Nextimage will display the scanner name in the top-left corner of the program interface.

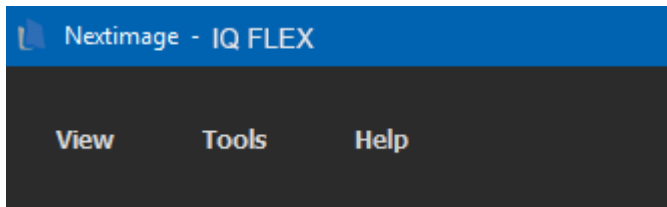

NOTE: When Nextimage first loads you will be asked to supply your email address and company name in order to continue.

IQ FLEX can now be controlled from Nextimage using Wi-Fi or a cabled network connection.

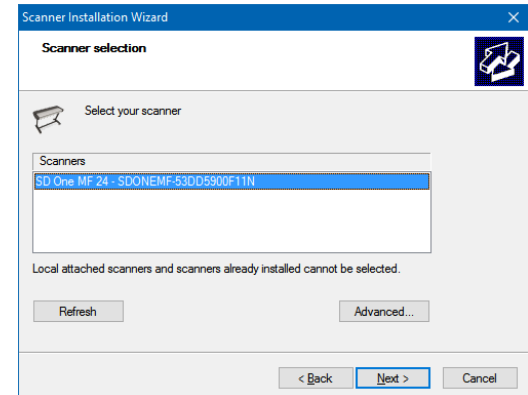
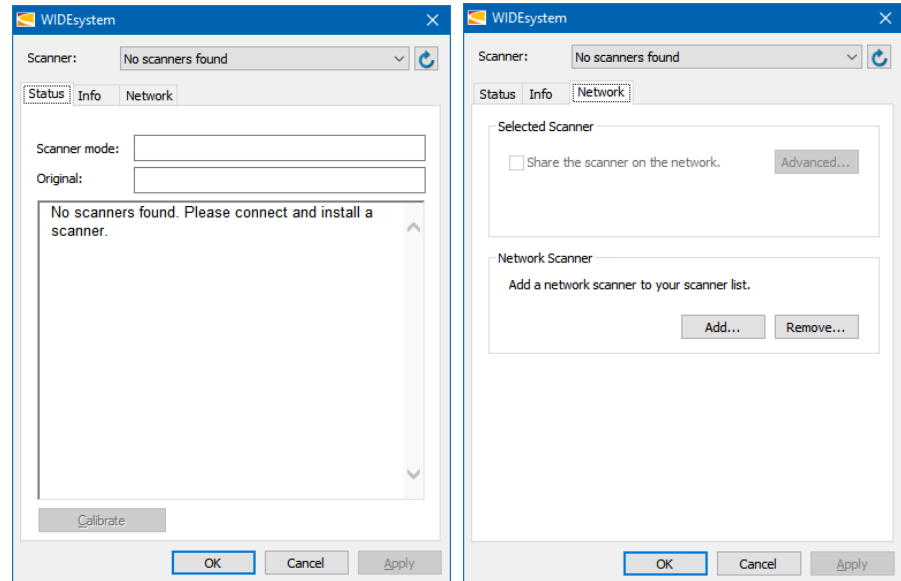

Administrator console

The IQ FLEX scanner permits remote configuration and access to scanner activity logs through its Administrator console using any web browser with access to the same network as the scanner.

Connect by typing the scanner IP address into any web browser address line.

http://192.168.50.93/admin

Administrator provides the following functions:

- HOME**Homepage with serial number of scanner and installed firmware level.
- WIFI**Lists all visible Wi-Fi networks and permits selection and connection with password. Hidden networks not supported.
- EMAIL**.....Enables remote configuration of email host, port, security, account, password, name and maximum size of attachment.
- CONTACTS**.....Lists email contacts already in use with the device. New contacts can be added.
- DATE/TIME**Display and correct the date and time stored in the scanner.
- SIZES**Display and control the paper size standard and measurement units used by the scanner
- LANGUAGE**Choose the language of the user interface and the keyboard independently.
- TIMERS**Display and control the 'revert to defaults' and 'scanner enter sleep mode' timers.
- SYSTEM**Access to reset, reboot, set password and set hostname (service engineer only) functions.
- LOGS**.....Scanner activity logs (service engineer only)



[Settings > About]

Scanner maintenance tasks

Scanner maintenance will ensure optimal performance of your scanner. There are 2 basic maintenance tasks:

1. **Cleaning**

Keep your scanner clean – the next section describes how to thoroughly clean the internal scan area. How often you need to clean will depend on how often and the types of media you scan. If your work primarily involves scanning newspapers and old blueprints you may need to clean more often than users who only scan brochures and new drawings. Be sure to clean the scanner when results are not optimal. See more under the section: *Cleaning the scan area*.

2. **Calibration**

Calibrate the scanner if your output is not optimal and cleaning (above) does not remedy the problem. Calibration will renew the scanner's original color and BW precision. Scanner Calibration is easy to perform. Just insert a Calibration Sheet and run the Calibration Wizard.. Make sure the scanner is clean before calibrating. See more under the section: *Scanner Calibration*.

3. **Replacing worn parts**

Replacement of parts should be carried out when you get a warning on your screen or when a worn part affects your results. Replaceable parts are:

- The white background platen.

See more under the section: *Replacing scanner parts*.

Cleaning the scan area

43

Turn scanner power OFF and disconnect the power supply

1. Press the scanner power switch to OFF (to the right)
2. Pull out or switch off the external scanner power supply at the socket

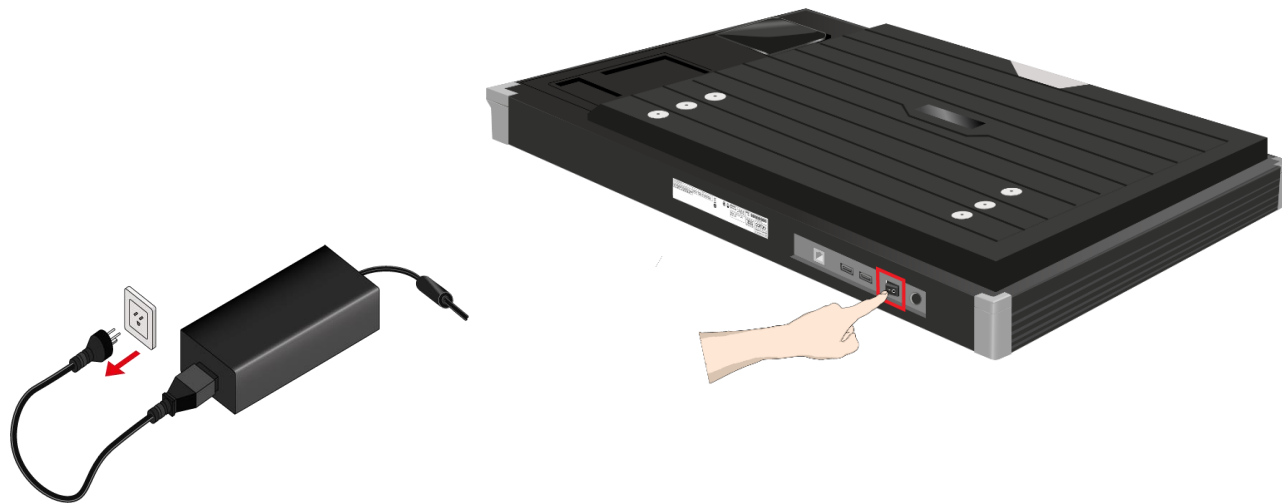

Cleaning the glass

44

Cleaning the scan glass

Be sure to clean the scan area when results are not optimal. Even small dust particles in the scan area can cause streaks in your scanned image.

To clean the scan area

Open the lid then follow the instructions below.

1. Use a lint-free cloth and a mild, streak-free, glass cleaner.
2. Dry the glass completely using a separate clean, dry lint-free cloth like the one provided with the maintenance kit.

 **Caution:** Do not use abrasives, acetone, benzene or fluids that contain these chemicals. Do not spray liquids directly onto the scanner glass-plate or anywhere else in the scanner.



Replacing the white background platen

45

Replacing a worn white background platen

The white background platen of the scanner can become worn and discolored after long periods or very heavy use. A replacement fresh white background platen can be obtained from your dealer as a purchased consumable item.

The background pressure platen is located using 17 key-hole locating pegs.

First raise the lid of the scanner.

1. With two hands take the platen and gently lift it up roughly 5mm (0.2") so that the pegs line up with the holes
2. Now lift the platen forward and clear of the scanner taking care not to drop it onto or scratch the scanner glass.
3. Refitting is the reversal of removal



Caution: We recommend placing a piece of card or paper over the scanner glass to protect it before carrying out this process.

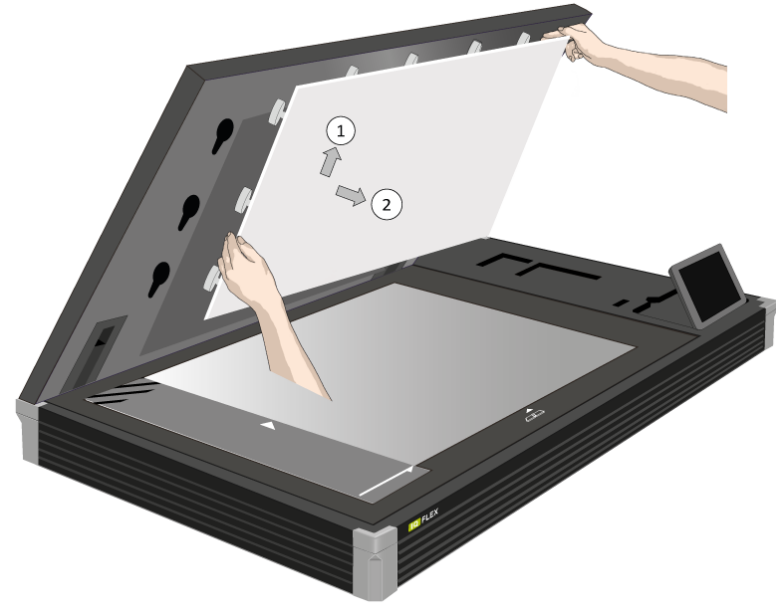

Preparing to calibrate the scanner

46

Turn ON scanner power

Turn ON the scanner power switch on the back of the scanner by moving the switch the left.

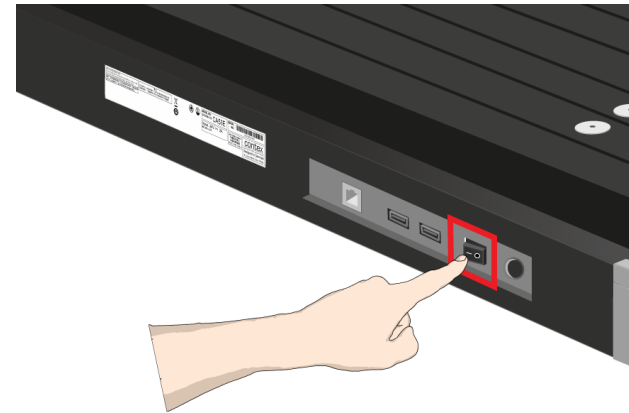

47

Launch the scanner calibration wizard



Ensure the scanner glass is clean. If it is dirty, clean it now to ensure the calibration process works uniformly across the calibration sheet.

Go to Settings on the touch screen



[Settings > Scanner > Calibrate]

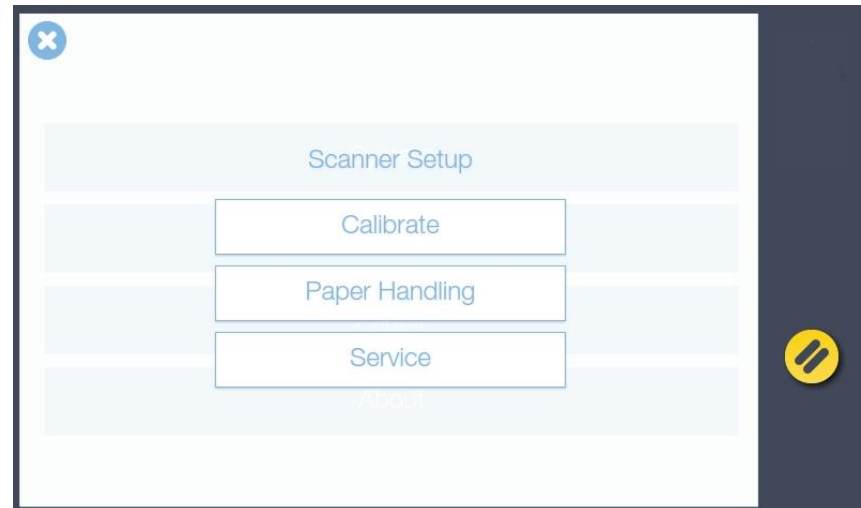

Calibrating the scanner

48

Insert the calibration sheet

During the process, the wizard will ask you to insert the *Calibration Sheet* that came with your scanner.

The printed side of the sheet must be inserted face down onto the scanner glass. Align the sheet midpoint arrow with the scanner midpoint arrow then close the lid of the scanner.

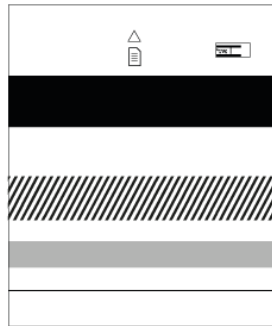

Click the wizard *Next* button to continue.

49

The program calibrates the scanner

The program works to calibrate black and white and color values. The calibration sheet will be rescanned a number of times.

The wizard will tell you when the process is finished.

1. Remove the scanner calibration sheet from the scanner.
2. Return the scanner calibration sheet to its protective cover and then place it in the storage folder.
3. Store the folder in a dry place and out of direct light.

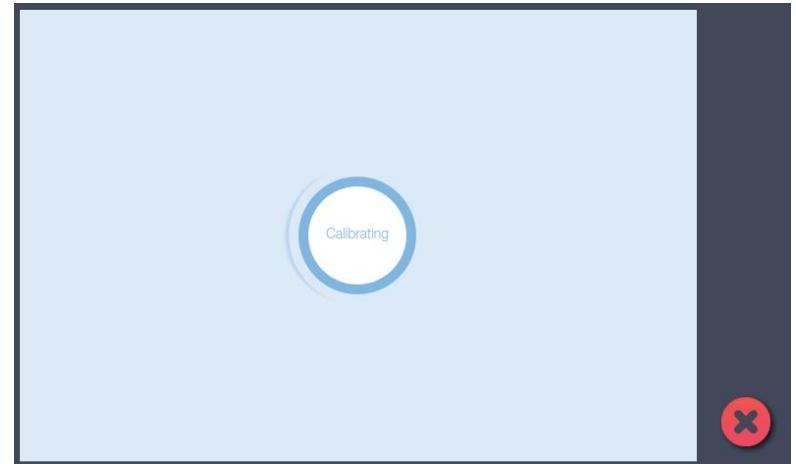

Updating your scanner software

Updates for your scanner software will be made available through your internet connection. Updating your software can take place automatically or manually.

Automatic updates

- The first time an update will be made available for your scanner, a notification will appear on your screen asking you to register for updates.
- Once you register, all future updates will be sent to your system automatically.
- When an update is available, you will receive a notification and can choose to activate the update immediately or wait until it is convenient.



Updating manually

You can also update your software manually through the scanner screen.



[Settings > System > Update]

Updating the Contex LINK client software

1. Make sure your PC is connected to the internet.
2. Start Contex LINK on the PC 
3. Press the setup icon. 
4. If the Update button is active, press the button to initiate the download and installation wizard.
5. Follow the instructions on your screen.



NOTE: You can also install Contex LINK from: <http://www.contex.com/LINK>



Contex LINK scan client software update: Press the **Update** button.

Troubleshooting your scanner

This section describes trouble-shooting procedures for the most common issues that can arise with your scanner. Please look for a problem description that matches your actual situation. If found, perform the recommended trouble-shooting procedures before requesting a service call.

Technical Service



In some cases you may need technical assistance. You should contact your service provider if one or more of the following cases is true:

- The error cannot be remedied through the action suggested on your screen.
- The error and its remedy is not described in this users guide.
- The system fails to report the error on your screen.



NOTE: See your manufacturer's website for service provider contact information if you are unsure.

In order to get the best and fastest solution to your problem, you should prepare as much information as possible before calling your service provider for technical assistance.

1. Write down your **scanner model name and serial number**. The serial number is printed on the label on the underside of the scanner's lid. Open the lid to view the label.
2. Write down your **firmware and software** versions: If your software interface is up and running select: -> *About* 
3. Write down your **Contex LINK (client software) version** – Open the Contex LINK software on your PC. The version number is displayed at the top.
4. Write down **the scanner IP address**. This could be useful for getting remote support online. To see the scanner IP select -> *Settings* -> *About* 
5. To help technical service solve the issue as fast as possible, **you can additionally provide log files** containing important data from your scanner.

To supply the scanner logs: Select the Settings icon: -> Scanner -> Service



Now select your method for saving or sending the log files:

- Select **Send info by email** to send log files to your service provider. This requires that the outgoing email server settings are applied and your scanning is running. See section *Installation* for details.
- Choose **Save info to USB** to copy the log files to a USB key. You will need to insert the USB key into the socket provided on the top of the scanner.

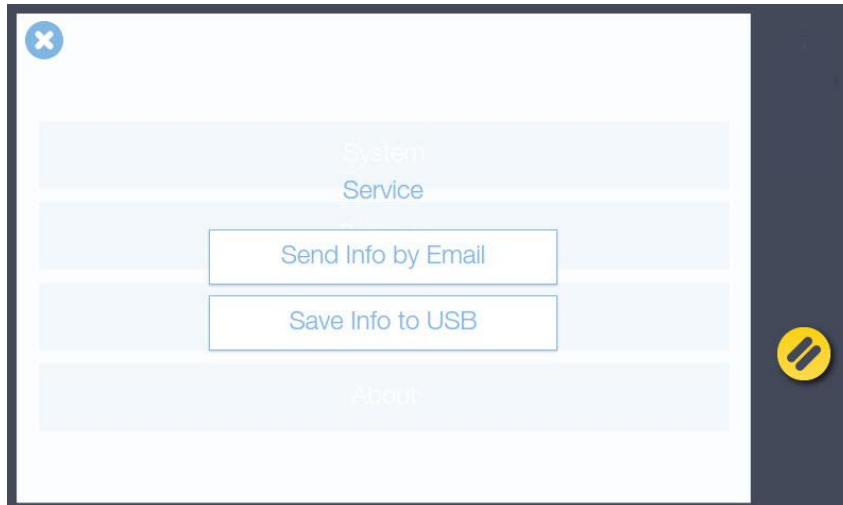







Send or save the scanner log files. These will help your service technician locate and solve the problem.

Problems with the scanner installation

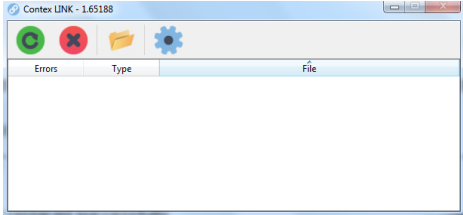
Problem	Possible Causes and Remedies
Error message during Scanner Calibration:	<p>This message may appear when running the <i>Calibration</i> wizard.</p> <ol style="list-style-type: none">1. The most common cause is a dirty or smudged glass plate. Clean the scanning area, reboot the scanner and then complete the calibration steps as described in the section: <i>Scanner Calibration</i> in this guide.2. If the problem persists after cleaning the scanning area - the problem could be caused by a loose object in the optical path. Remove any torn pieces of paper or other loose objects from the scanning area. Even the smallest loose objects will disturb the scanner adjustment function.3. Contact your technical service provider if the problem persists.
Cannot scan to a cloud service	<p>You get a message on the scanner screen: "Welcome to Contex LINK, <cloud service name> is not enabled" ...</p> <ol style="list-style-type: none">1. Ensure that you have installed the Contex LINK client software on your PC, and that you have setup the parameters for the specific cloud service. See the section: <i>The Contex LINK scan client software</i> for instructions.2. If you have made the settings, test your login credentials to the cloud service from your PC.3. Repeat the cloud service setup in Contex LINK.4. Ensure that you have the latest version of the Contex LINK software on your PC. If not, update Contex LINK and repeat above steps. See: <i>Updating the Contex LINK client software</i>.
Can't find myself as a user on the scanner	<p>You scroll through the available users on the scanner screen and cannot find yourself as a user. Try the following steps:</p> <ol style="list-style-type: none">1. Ensure that you have installed the Contex LINK client software on your PC, and that you have setup the user parameters correctly. See the section: <i>The Contex LINK scan client software</i> for instructions on installing the client software and connecting to your cloud services.2. Restart the scanner to let it redetect all users on the LAN.3. If the above fails, update the Contex LINK software on your PC and repeat above steps. See: <i>Updating the Contex LINK client software</i>.

Problems operating the scanner

Problem	Possible Causes and Remedies
<p>I can't find my scan files after scanning</p>	<p>You selected scan to PC or scan to a cloud service but you cannot locate your scan file.</p> <ol style="list-style-type: none"> 1. If is running correctly you can locate your files in the following location for each destination: <ol style="list-style-type: none"> a. Scan to PC: Select the folder icon at the top of the Contex LINK scan client interface to access the file  b. Scan to cloud service Box: the <i>Contex Solutions</i> folder in the root c. Scan to cloud service Google Drive: the <i>Contex Solutions</i> folder in the root d. Scan to cloud service OneDrive: the <i>Contex Solutions</i> folder in the root e. Scan to cloud service Dropbox: the <i>Contex Solutions</i> folder in the <i>Apps</i> folder 2. If the file transfer failed you will see the file listed in the Contex LINK error log. Start Contex LINK on the PC to view.  <div data-bbox="691 696 1153 908" style="border: 1px solid #ccc; padding: 5px; margin: 10px 0;">  </div> <p style="text-align: center;"><i>Contex LINK error log screen</i></p>
<p>I cannot scan to email</p>	<p>You selected scan to email and entered the right email address. But you receive an error and the scanner email icon is marked with a red dot. </p> <p>The outgoing mail parameters may not be configured correctly in the scanner. Go to -> Settings -> System -> Email to configure the outgoing email settings. See the section 'Configuring the scan to email settings' for more detail about the email parameters and what they mean. </p> <p> NOTE: The email settings relate to your company IT and its unique email solution. You may need to seek support from your IT department or IT expert.</p>

Problems with the scan result

Problem	Possible Causes and Remedies
<p>Scanning: The colors in my scan are not correct in relation to the original document</p>	<p>Please carry out a calibration of the scanner. Calibration adjusts the color settings.</p> <ol style="list-style-type: none"> 1. Thoroughly clean the scanning area. See: Cleaning the scan area for instructions. 2. Run the calibration wizard and follow the steps described in the section Scanner Calibration in this guide 3. Be sure to choose full calibration.
<p>Copying - The colors in my printed output were not copied correctly in relation to the original document</p>	<ol style="list-style-type: none"> 1. Make sure that the Media setting matches the media loaded in the printer. See: Copy settings for more details. If they are wrong correct to the right media. 2. If you have used the correct Media setting in the Copy settings, you should recreate a new media profile: <ol style="list-style-type: none"> a) Thoroughly clean the scanning area. See: Cleaning the scan area for instructions. b) Run the calibration wizard and steps as described in the section: Scanner Calibration in this guide. Be sure to choose full calibration. <p>Now create a new Media profile:</p> <ol style="list-style-type: none"> c) Select -> Settings -> Printer d) Select Media Profile to start the media profile wizard to create a new media profile. e) Follow the instructions on your screen. See more in: Set up your printer's media profiles. 
<p>Entire image is not scanned</p>	<p>Make sure that you are loading the original correctly:</p> <ol style="list-style-type: none"> 1. Be sure to align the center of the original with the scanner center arrow mark. 2. Load with the printed side face up.

Problem	Possible Causes and Remedies
Large empty areas on both sides of the image	<p>Go to the Area option in your scan settings before pressing the green go button.</p> <ul style="list-style-type: none">• The All setting means that the scanner will disregard the original's size and capture the whole scanner width which will add white space on both sides of the document.• Select Auto if you only want to scan the width of the loaded document.
Whole image not scanned	<ul style="list-style-type: none">• Check in your scanning application that your size settings are either for Auto detection or correspond to the size of the whole original.• Check that you are loading the original correctly from the scanner's right side.

IMPORTANT SAFETY INSTRUCTIONS



Read all of these instructions and save them for later use. Follow all warnings and instructions marked on the scanner.

CAUTION:

RISK OF EXPLOSION IF BATTERY IS REPLACED BY AN INCORRECT TYPE.

DISPOSE OF USED BATTERIES ACCORDING TO THE INSTRUCTIONS.



Warning: Keep fingers away from holes on the bottom side of the scanner.

A. Do not place the scanner on an unstable surface, stand, cart or table. Serious damage can be caused if the unit falls.

B. When cleaning, do not spray/apply liquid cleaners directly onto the scanner parts. Apply liquids to your cloth and then use the dampened cloth to clean.

C. Before **cleaning** or replacing any **user-replaceable parts**, be sure to turn the scanner power off and disconnect the power plug.

D. The scanner should be operated from the power source type indicated on the marking label. If you are unsure of the type of power available, consult your dealer or local power company.

E. The scanner is intended for use on IT, TT and TN power distribution systems, and is equipped with a three-wire grounding type plug. This plug will fit only into a grounding-type power outlet. This is a safety feature which relies on building installation. If you are unable to insert the plug into the outlet contact your electrician to replace your obsolete outlet. Do not defeat or ignore the purpose of the grounding-type plug.

F. Do not allow anything to rest on the power cord. Do not locate the scanner where persons will walk on the cord.

G. If an extension cord is used with the scanner, make sure that the total ampere ratings of the products plugged into the extension cord does not exceed the extension cord ampere rating. Make sure that the total rating of all products plugged into the wall outlet does not exceed 15 amperes.

H. Slots or openings in the cabinet at the back or bottom are provided for ventilation. This ensures reliable operation of the product and protects it from overheating. These openings must never be blocked or covered. The openings should never be blocked by placing the unit on a bed, sofa, rug, or other similar soft surface. This product should never be placed near or over a radiator or heat register. This product should not be placed in a built-in installation unless proper ventilation is provided.

I. Never push objects of any kind into the scanner through cabinet slots since they may touch dangerous voltage points or short out parts that could result in a risk of fire or electrical shock. Avoid any possibility of spilling liquid of any kind on the scanner.

J. Do not attempt to service the scanner yourself. Opening or removing those covers requiring tools may expose you to dangerous voltage points or other risks. Refer all servicing in those compartments to authorized service personnel.

K. Unplug the scanner from the wall outlet and refer servicing to authorized service personnel under the following conditions:

- When the power cord or plug is damaged or frayed.
- If liquid has been spilled into the scanner.
- If the scanner has been exposed to rain or water.
- If the scanner does not operate normally when operating instructions are followed then adjust only those controls covered by the instructions in this manual. Improper adjustment of controls other than those mentioned in this manual may result in permanent damage and will at best require extensive work by a qualified technician to restore this product to its normal operation.
- If the scanner has been dropped or the cabinet has been damaged.
- If the scanner exhibits a distinct change in performance, indicating a need for service.

REGULATIONS

FCC Regulations

USA

NOTE: This equipment has been tested and found to comply with the limits for a Class A digital device, pursuant to Part 15 of the FCC Rules. These limits are designed to provide reasonable protection against harmful interference when the equipment is operated in a commercial environment. This equipment generates, uses, and can radiate radio frequency energy and, if not installed and used in accordance with the instruction manual, may cause harmful interference to radio communications. Operation of this equipment in a residential area is likely to cause harmful interference in which case the user will be required to correct the interference at his/her own expense.

Caution: Pursuant to Part 15.21 of the FCC Rules, any changes or modifications not expressly approved by the manufacturer may cause harmful interference and void the use's authority to operate the equipment.

CE Regulations

EU

This is a Class A product. In a domestic environment this product may cause radio interference in which case the user may be required to take adequate measures.

VCCI Regulations

Japan

This equipment has been tested and found to comply with the limits for a Class A product according to Agreement of VCCI: 2008 (CISPR 22).

この装置は、クラスA情報技術装置です。この装置を家庭環境で使用すると電波妨害を引き起こすことがあります。この場合には使用者が適切な対策を講ずるよう要求されることがあります。 VCCI-A

Toxic or Hazardous Substances or Elements

有毒有害物质或元素名称及含量

Part Name 部件名称	Toxic or hazardous Substances and Elements 有毒有害物质或元素					
	Lead (Pb) 铅	Mercury (Hg) 汞	Cadmium (Cd) 镉	Hexavalent Chromium (Cr (VI)) 六价铬	Polybrominated biphenyls (PBB) 多溴联苯	Polybrominated diphenyl ethers (PBDE) 多溴二苯醚
Scanner 荧光灯管	○	○	○	○	○	○
<p>O: Indicates that this toxic or hazardous substance contained in all of the homogeneous materials for this part is below the limit requirement in SJ/T11363-2006.</p> <p>表示该有毒有害物质在该部件所有均质材料中的含量均在SJ/T11363-2006标准规定的限量要求以下。</p> <p>X: Indicates that this toxic or hazardous substance contained in at least one of the homogeneous materials used for this part is above the limit requirement in SJ/T11363-2006.</p> <p>表示该有毒有害物质至少在该部件的某一均质材料中的含量超出 SJ/T11363-2006 标准规定的限量要求。</p> <p>(Enterprises may further provide in this box technical explanation for marking "X" based on their actual conditions. 企业可在此处根据实际情况对上表中打“X”的技术原因进行进一步说明。)</p>						

WARNING

IR and UV may be emitted from lamp unit when scanning. Avoid using the scanner with the lid open.

If using scanner with open lid do not look directly at light from lamp unit and do not use hand to hold object to be scanned by hand.